



**Project No. Coll – Ct - 2003 - 500291**

**ESECMaSE**

**Enhanced Safety and Efficient Construction of Masonry Structures in Europe**

Horizontal Research Activities Involving SMEs

Collective Research

**D 7.2 C Stress-strain-relation of perforated bricks (4-brick-specimen)**

Due date of deliverable: 03-08

Actual submission date: 04-08

Start date of project: 10.June 2004

Duration: 45 month

National Technical University  
of Athens - Laboratory  
for Earthquake Engineering  
Polytechnic Campus  
157-00 Zografos-Athens/Greece

[draft 1]

<b>Project co-funded by the European Commission within the Sixth Framework Programme (2002-2006)</b>		
<b>Dissemination Level</b>		
<b>PU</b>	Public	X
<b>PP</b>	Restricted to other programme participants (including the Commission Services)	
<b>RE</b>	Restricted to a group specified by the consortium (including the Commission Services)	
<b>CO</b>	Confidential, only for members of the consortium (including the Commission Services)	

## INDEX

1	Introduction	2
2	Specimens	2
3	Testing set-up- Instrumentation	6
4	Earthquake Tests	10
4.1	Random test	10
4.2	Time history tests	14
5	Test Facility	18
5.1	Location.	19
5.2	Test equipment description and calibration	19
6	Reanalyzing of test results	20
6.1	Analysis of test data	20
6.2	Damages	20
6.2.1	<b>Specimen A1</b> –Silicate Calcium optimised units	20
6.2.2	<b>Specimen A2</b> –Silicate Calcium optimised units with vertical perforation	21
6.2.3	<b>Specimen A3</b> –Silicate Calcium optimised units with vertical perforation and vertical confinement.	22
6.2.4	<b>Specimen B1</b> –Clay optimized units	24
6.2.5	<b>Specimen B2</b> – First series of test- two story building - Clay units- Horizontal walls with clay infill blocks	24
6.2.6	<b>Specimen B3</b> –Two story building - Clay units- Horizontal walls with clay infill blocks+ reinforcement	26
6.2.7	<b>Specimen B4</b> –Two story building – Lightweight aggregate concrete blocks	28
6.3	Acceleration Amplification Factor	29
6.4	Hysteretic loops	34
6.5	Story drift	42
6.6	Computation of ductility $\mu$ and behaviour factor $q$	49
7	Conclusions	54

Appendix A: Time histories of Specimen A1

Appendix B: Time histories of Specimen A2

Appendix C: Time histories of Specimen A3

Appendix D: Time histories of Specimen B1

Appendix E: Time histories of Specimen B2-two stories specimen

Appendix F: Time histories of Specimen B2- one story specimen

Appendix G: Time histories of Specimen B3

Appendix H: Time histories of Specimen B4

## 1 Introduction

This report provides a detailed account of shaking table tests of seven full-scale masonry specimens performed at the shaking table of Laboratory for Earthquake Engineering (LEE) of the National Technical University of Athens (NTUA), Greece. This research is a part of the 7<sup>th</sup> Work Package named “Static and Dynamic Shear Tests on Structural Members” of ESECMaSE project– “Enhanced Safety and Efficient Construction of Masonry Structures in Europe”. The main scope of this research project is the investigation of lateral resistance of masonry building (design and test method) and the improvement of masonry materials and structure to provide higher resistance in lateral loads.

Three types of units were examined: optimised calcium silicate units (CS), clay units (C) and lightweight aggregate concrete units (LAC). The primary test for each specimen was an earthquake test in plane direction using an artificial time history generated to match EC8 design spectrum. Several tests were performed with the acceleration of the shaking table to be scaled step-wise, up to the failure of each specimen. Random vibration test was carried out as complementary testing before earthquake simulation tests in order to identify the natural frequencies and damping ratios of each specimen.

## 2 Specimens

Seven full-scale two stories masonry buildings with concrete slabs were constructed. Each specimen consists of T-shaped part and a wall on the opposite side as showed in Figure 1. The flange of the T wall as well as the parallel wall on the opposite side and the length of the web have width of 1.50m. The thickness of the wall is 0.175m. Steel strips connect the web and flange of the T- shaped wall. The story height is 2.51m for clay masonries considering 1cm of normal mortar in the lowest layer and 2.55m for calcium silicate masonries considering initial layer of 5cm due to the large size of masonry blocks. The reinforced concrete slab of two stories has thickness of 12cm. The slabs were prefabricated. The steel base for the construction of specimens, a plan and front view of masonry specimen are shown in Figure 1 to 4. The density of optimized calcium silicate units is  $1.8\text{Mg/m}^3$ , the density of optimized clay units is  $0.8\text{Mg/m}^3$ , the density of clay infilled block is  $2.00\text{Mg/m}^3$  including infilled concrete and the density of lightweight aggregate concrete is  $1.60\text{Mg/m}^3$ .

The examined masonry specimens are coded as following:

### **A: Calcium Silicate (CS)**

Specimen A1: Masonry building with CS optimised units.

Specimen A2: Masonry building with CS optimised units with vertical perforation.  
 Specimen A3: Masonry building with CS optimised units with vertical perforation and vertical confinement (edge reinforcement inside outmost perforation holes).

**B: Clay (C)**

Specimen B1: Masonry building with Clay optimised units.  
 Specimen B2: Masonry building with Clay infill blocks  
 Specimen B3: Masonry building with Clay infill blocks with vertical confinement, (edge reinforcement inside outmost perforation holes).

**Lightweight aggregate concrete (LAC)**

Specimen B4: Masonry building with lightweight aggregate concrete units.

According to original design, the distance between the two parallel walls was less than 3.70m. After the meeting in Athens, on 24 of April 2006, the final configuration of masonry building was decided. In Figures 5 and 6 the construction phase of specimens is presented.

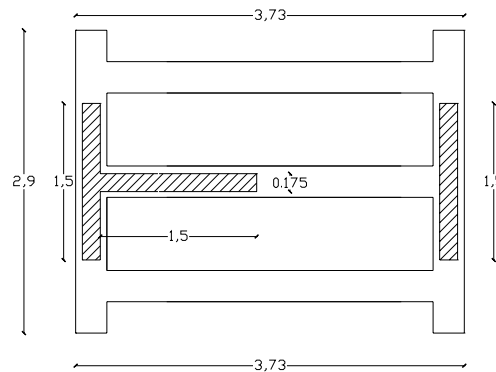

Figure 1. Plan view of masonry specimens: arrangement of walls.

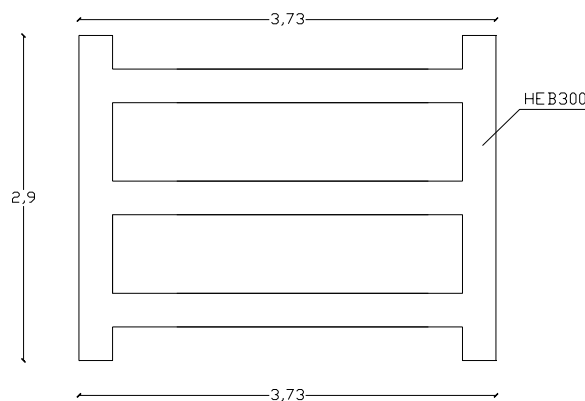

Figure 2. Plan view of steel base.

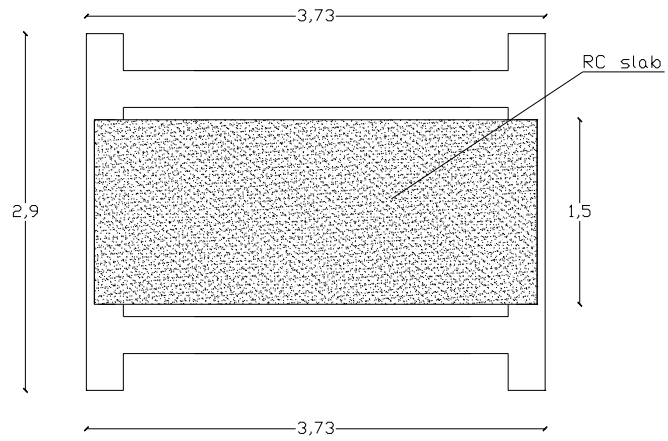

Figure 3. Plan view of masonry specimens: reinforced concrete slab.

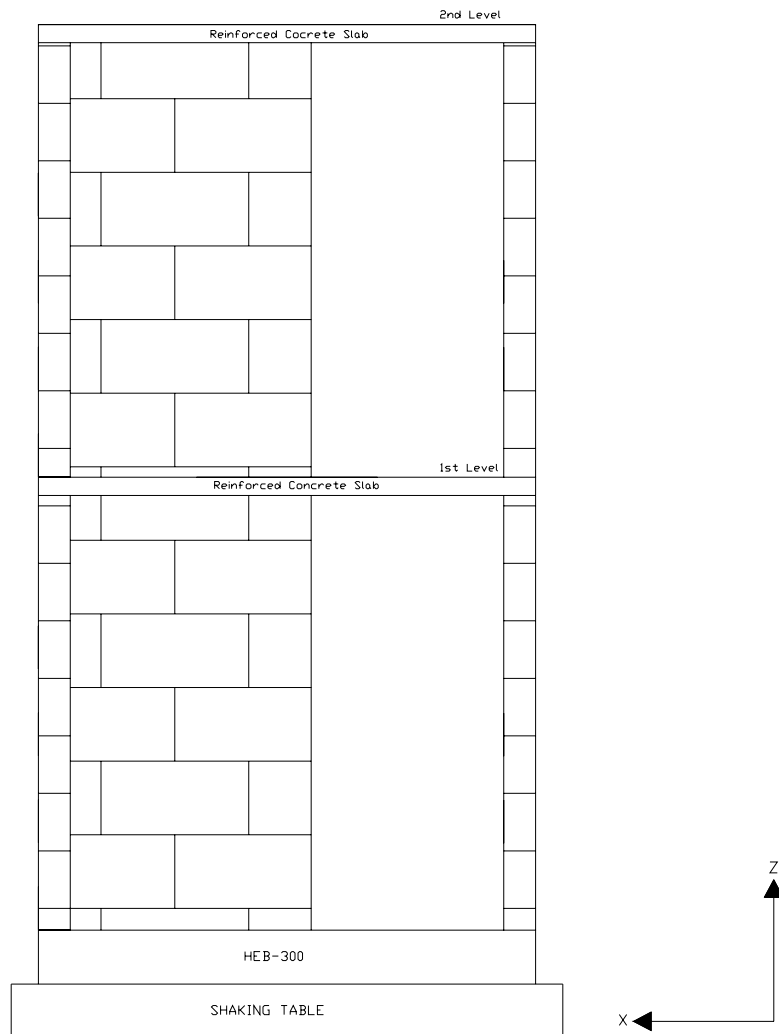

Figure 4. Front view.



Figure 5. Construction of calcium silicate masonry buildings.



Figure 6. Construction of clay masonry buildings.

A special mechanic was also designed for the transportation of specimens on the shaking table. Six wheels are fixed on six special steel plates, which are attached to the steel base. A hydraulic actuator is used to give the appropriate pressure to the wheels, which are designed to carry the self-weight of moving structure.

### 3 Testing set-up- Instrumentation

Each specimen was fixed on the shaking table using the steel base, which was fixed rigidly on the shaking table through 36 bolts M30. The first specimen (A3) initially has been tested without any additional mass. Then it was decided to place additional mass of 7Mgr on the concrete slab of first Level. For all the other specimens the arrangement of additional mass was the same, where 3.50ton and 4.0ton placed on the first and second level respectively. The arrangement of masses on 1<sup>st</sup> and 2<sup>nd</sup> level is shown in Figure 7. In Table 1 the self mass, the additional and the total mass of each specimen is given.

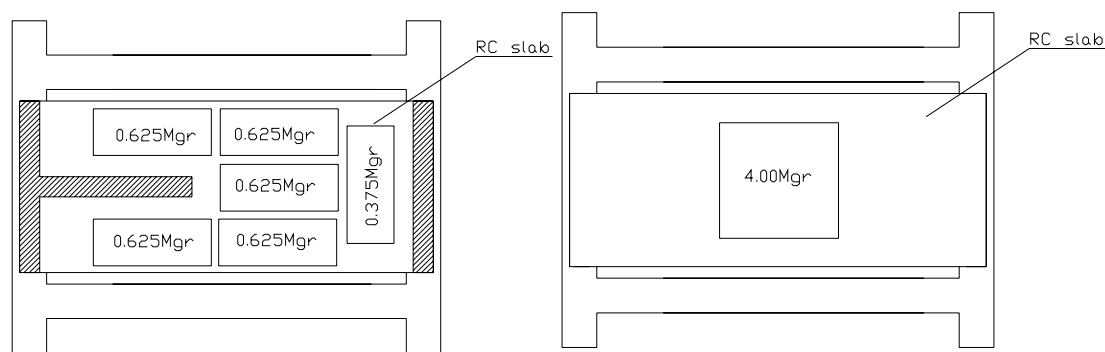

Figure 7. Arrangement of additional masses: Plan view: (a) 1<sup>st</sup> level, (b): 2<sup>nd</sup> Level (Specimen A1- A2, B1- B4).

Table 1. Self mass, additional mass, total mass of specimens

Specimen	Self masst (Mgr)	Additional Mass (Mgr)		Total (Mgr)
		1 <sup>st</sup> Level	2 <sup>nd</sup> Level	
A1	10.06	3.50	4.00	17.56
A2	10.06	3.50	4.00	17.56
A3	10.06	7.00	-	17.06
B1	6.26	3.50	4.00	13.76
B2	10.8	3.50	4.00	18.30
B2**	5.40	3.50	-	8.90
B3	10.8	3.50	4.00	18.30
B4	9.63	3.50	4.00	17.13

\*\* One story specimen

In Figures 8 to 10 a whole view of calcium silicate, clay and lightweight aggregate concrete specimens on the shaking table are presented.



Specimen A1



Specimen A2



Specimen A3

Figure 8. Specimens constructed using calcium silicate units.





Specimen B1



Specimen B3

Figure 9. Specimens constructed using clay units.



Figure 10. Specimen B4 with Lightweight concrete blocks.

Instrumentation of each masonry building was organised to measure: in plane accelerations at each level (A1X and A2X), the total displacements (D1, D2, D3 and D4), relative in plane diagonal displacements (D6, D8, D11 and D13), relative

movement between web and flange of T-shaped wall (D7, D12) and relative vertical displacements (D9, D5 and D10). The accelerometers that were used are made by Kyowa/Japan and Endevco/Usa, while the displacement transducers are made by Celesco. The instrumentation set-up was the same for all the specimens and is presented in Figures 11 - 13. During testing specimen B4, the vertical displacement at measurement point D9 was not used.

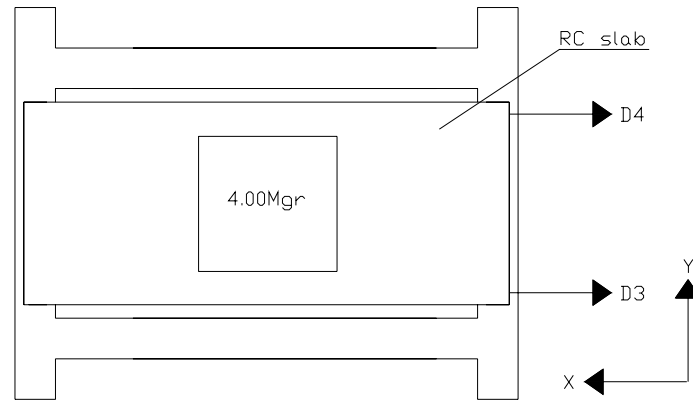

Figure 11. Instrumentation set-up: 2<sup>nd</sup> Level - Plan view.

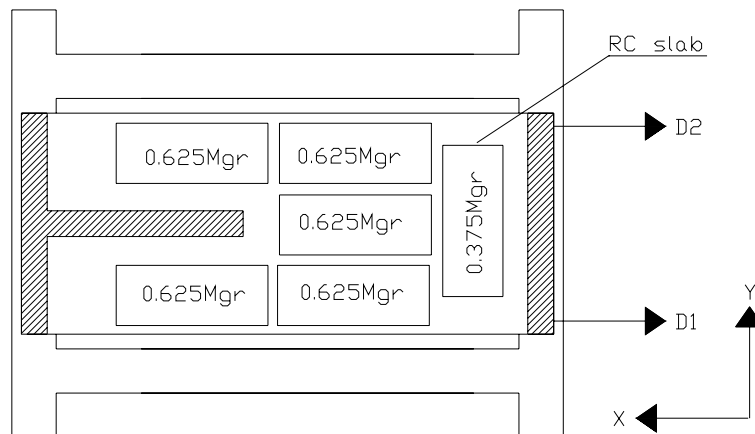

Figure 12. Instrumentation set-up: 1<sup>st</sup> Level - Plan view.

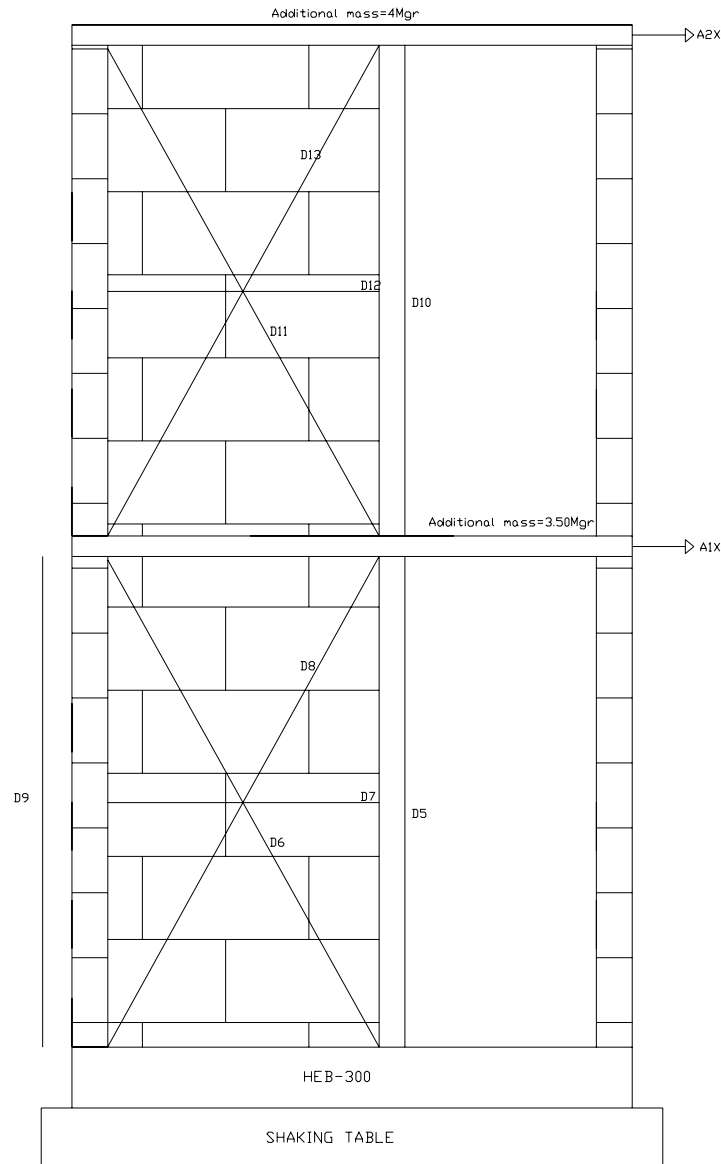

Figure 13. Instrumentation set-up.

#### 4 Earthquake Tests

Two different types of tests were performed. An artificial time history generated to match EC8 design spectrum was used for earthquake tests while a random signal was applied prior to earthquake tests in order the dynamic characteristics of each specimen to be determined. The testing procedure was the same for all the specimens.

##### 4.1 Random test

Each specimen was excited by a random acceleration signal along X (in plane) axis. The frequency range of random test was from DC to 50Hz and the amplitude of vibration was 0.02g.

These tests were performed in order the natural frequencies and the damping ratio of each specimen to identify. In Table 2 the fundamental natural frequencies and damping ratio of each specimen are shown. The natural frequencies were directly measured from the peak values of the transfer functions between the base acceleration and response acceleration of each specimen at the top level. Damping ratios were calculated by using the half power bandwidth method. After the end of tests of Specimen B2, the 2<sup>nd</sup> level was removed and the one story specimen (coded as B2\*\*) tested again. In Figures 14 to 21, the transfer functions are shown for each specimen. The dynamic characteristics of specimen A3 with additional masses was derived from sine logarithmic sweep test (frequency range 1-16Hz and amplitude of acceleration 0.04g).

Table 2. Measured natural frequencies and damping.

Specimen	Frequency (Hz)	Period (sec)	Damping (%)
A1	3.71	0.27	4.37
A2	3.91	0.26	3.96
A3- without additional mass	5.47	0.18	4.00
A3- with additional mass	4.98	0.20	3.46
B1	4.10	0.24	2.43
B2	4.39	0.23	2.17
B2**	7.28	0.14	4.15
B3	4.20	0.24	5.19
B4	4.59	0.22	3.71

\*\* one-story specimen

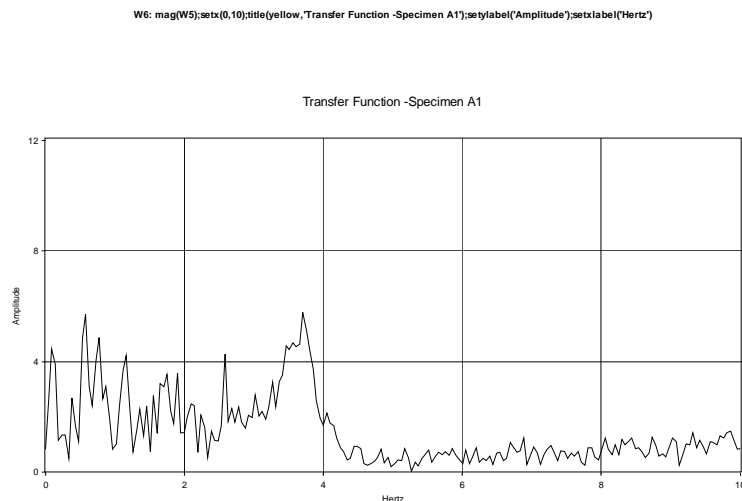

Figure 14. Transfer Function- Specimen A1.

W6: mag(W5);setx(0,10);title(yellow,'Transfer Function -Specimen A2');setylabel('Amplitude');setxlabel('Hertz')

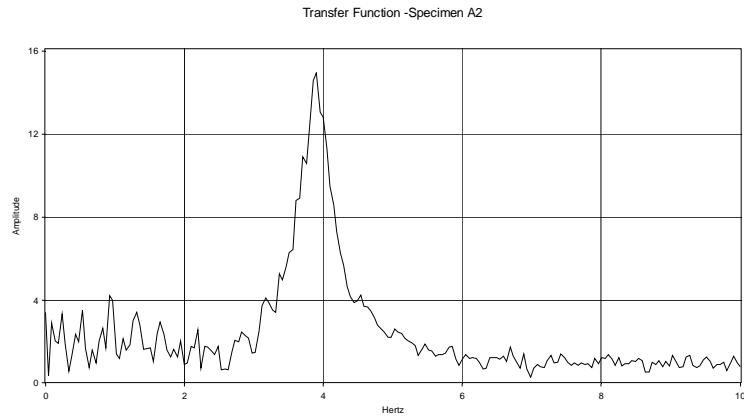

Figure 15. Transfer Function- Specimen A2.

W9: mag(W8);setx(2,10);title(yellow,'Transfer Function -Specimen A3');setylabel('Amplitude');setxlabel('Hertz')

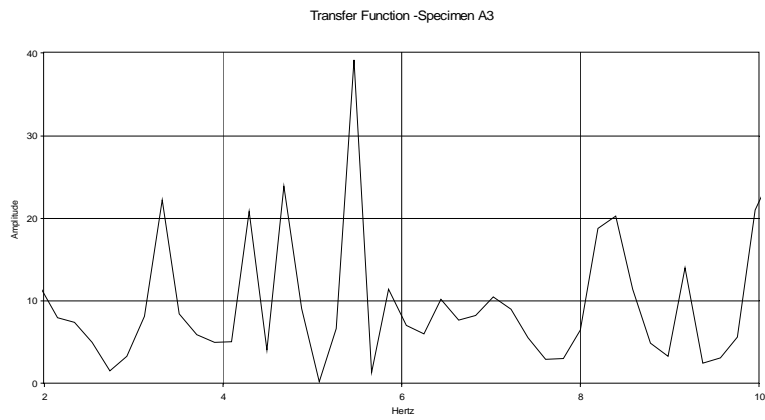

Figure 16. Transfer Function- Specimen A3- without additional masses.

W6: mag(W5);setx(0,10);title(yellow,'Transfer Function ');setylabel('Amplitude');setxlabel('Hertz')

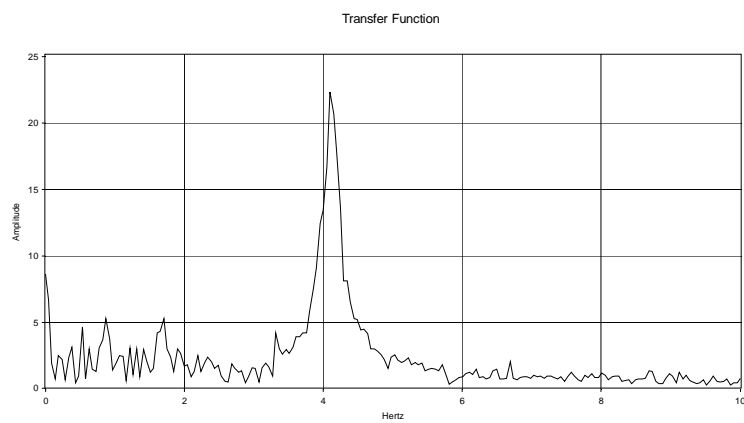

Figure 17. Transfer Function- Specimen B1.

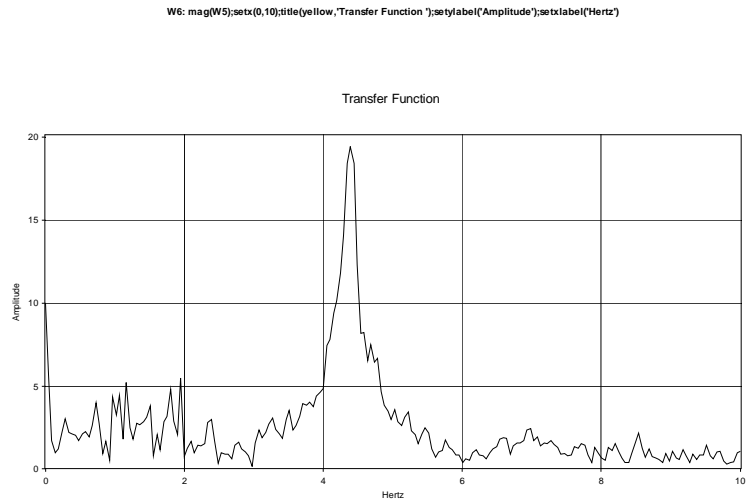

Figure 18. Transfer Function- Specimen B2.

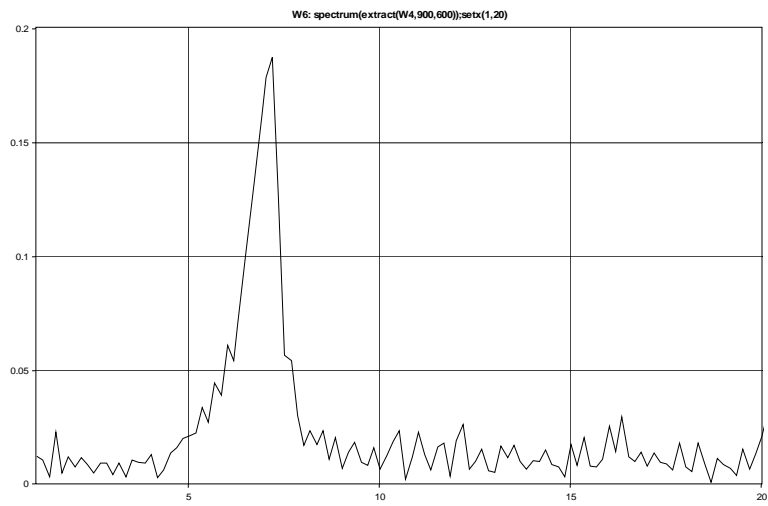

Figure 19. Spectrum Fourier – Specimen B2\*\*.

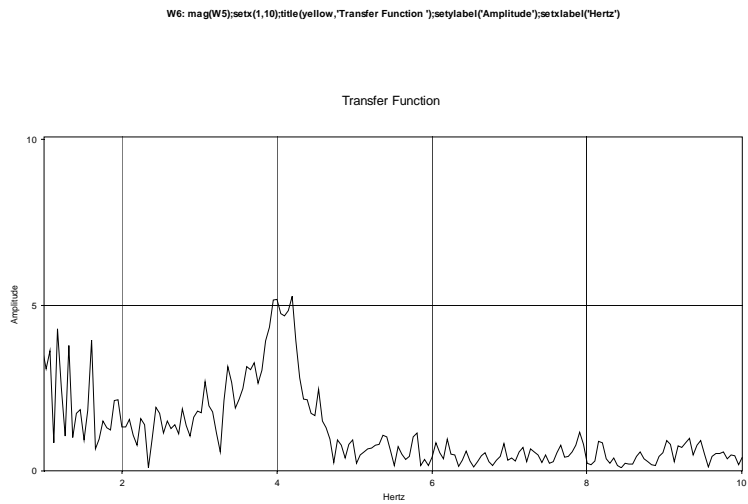

Figure 20. Transfer Function- Specimen B3.

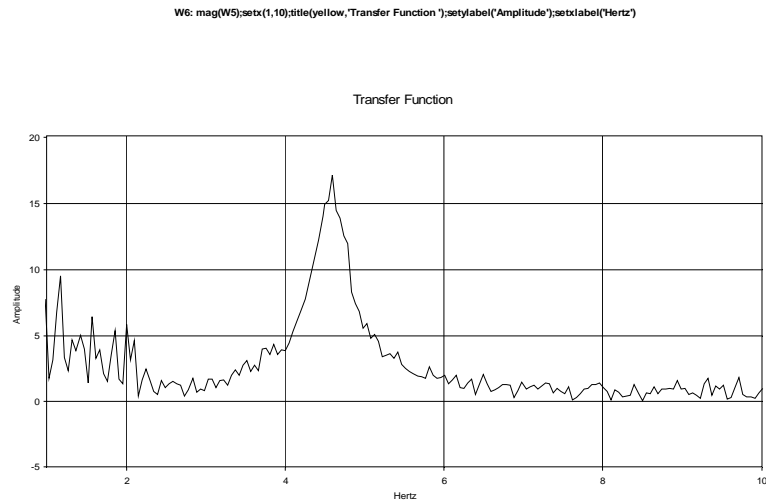

Figure 21. Transfer Function- Specimen B4.

#### 4.2 Time history tests

An artificial time history has been generated to match the EC8 design spectrum with the following characteristics:

Elastic Response Spectrum Type 1

Ground Acceleration 0.04g

Ground Category: B

In order to adjust to the available displacement capacity of the shaking table, the artificial accelerogram was filtered with a high pass filter of 1Hz.

The response spectrum Type 1 according to EC8 is shown in Figures 22, while in Figures 23 the generated acceleration time history is presented. In Tables 3 to 10 the testing procedure for each specimen is given.

Table 3. **Specimen A1**: Testing procedure-  
Testing date:02/10/2006

Test No.	Description	Nominal Acceleration (g)
1	Random Test	0.02
2	Earthquake Test	0.04
3	Earthquake Test	0.06
4	Earthquake Test	0.08
5	Earthquake Test	0.10
6	Earthquake Test	0.12
7	Earthquake Test	0.14
8	Earthquake Test	0.16

Type 1 Elastic Response Spectrum  
Ground Type B  
Ground Acceleration 0.04g

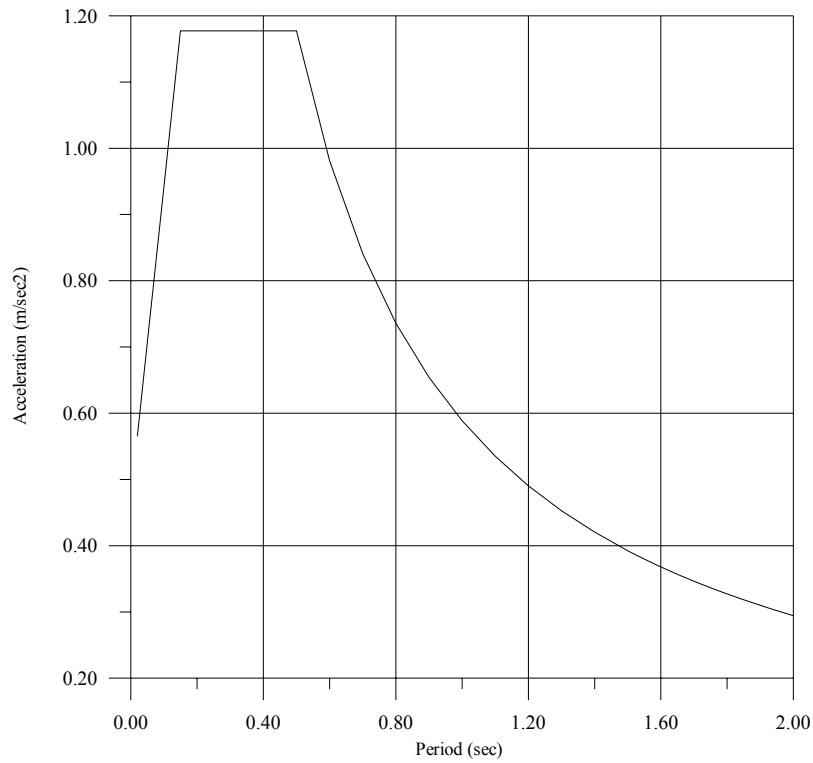

Figure 22. Elastic Response Spectrum Type 1 according to EC8.

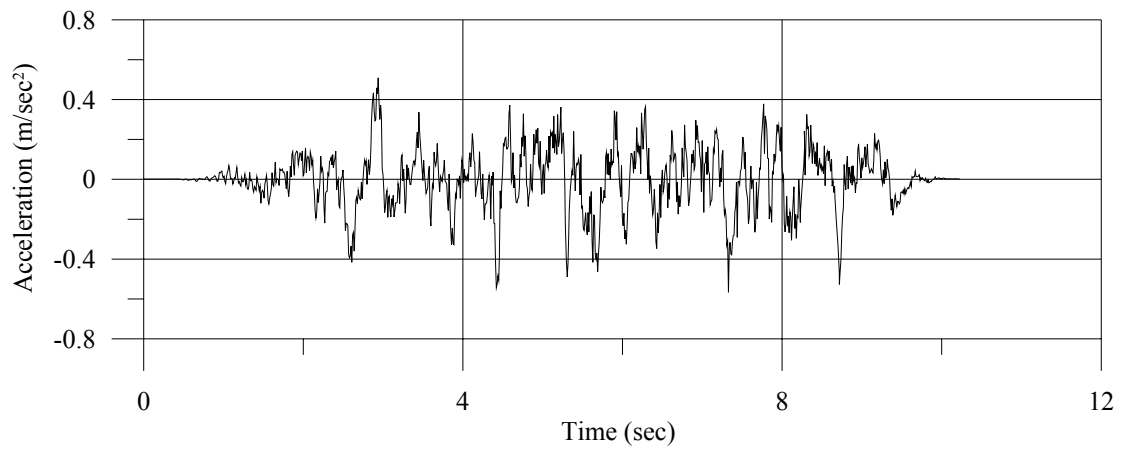

Figure 23. Artificial time history generated to match Elastic response Spectrum Type 1.



Table 4. **Specimen A2:** Testing procedure

Testing date:25/09/2006

Test No.	Description	Nominal Acceleration (g)
1	Random Test	0.02
2	Earthquake Test	0.04
3	Earthquake Test	0.06
4	Earthquake Test	0.08
5	Earthquake Test	0.10
6	Earthquake Test	0.12
7	Earthquake Test	0.14
8	Earthquake Test	0.16

Table 5. **Specimen A3:** Testing procedure

Testing date:7/07/2006, 26/07/2006,  
05/09/2006

Test No.	Description	Nominal Acceleration (g)
1	Random Test	0.02
2	Earthquake Test	0.02
3	Earthquake Test	0.04
Additional mass		
4	Sine Logarithmic sweep test	0.04
5	Earthquake Test	0.04
6	Earthquake Test	0.06
7	Earthquake Test	0.08
8	Earthquake Test	0.10
9	Earthquake Test	0.12
10	Earthquake Test	0.14
11	Earthquake Test	0.16
Restrain transversal walls		
12	Earthquake Test	0.04
13	Earthquake Test	0.08
14	Earthquake Test	0.12
15	Earthquake Test	0.16
16	Earthquake Test	0.20
17	Earthquake Test	0.20
18	Earthquake Test	0.24
19	Earthquake Test	0.28
20	Earthquake Test	0.30

Table 6. **Specimen B1**: Testing procedure

Testing date:15/12/2006

Test No.	Description	Nominal Acceleration (g)
1	Random	0.02
2	Earthquake Test	0.04
3	Earthquake Test	0.06
4	Earthquake Test	0.08
5	Earthquake Test	0.10
6	Earthquake Test	0.12
7	Earthquake Test	0.14
8	Earthquake Test	0.16
9	Earthquake Test	0.18

Table 7. **Specimen B2**: Testing procedure

Testing date:20/12/2006

Test No.	Description	Nominal Acceleration (g)
1	Random	0.02
2	Earthquake Test	0.04
3	Earthquake Test	0.06
4	Earthquake Test	0.08
5	Earthquake Test	0.10
6	Earthquake Test	0.12
7	Earthquake Test	0.14
8	Earthquake Test	0.16
9	Stop- collapse	-

Table 8. **Specimen B2\*\***: Testing procedure

Testing date:21/12/2006

Test No.	Description	Nominal Acceleration (g)
1	Random	0.02
2	Earthquake Test	0.18
3	Earthquake Test	0.18
4	Earthquake Test	0.20
5	Earthquake Test	0.22
6	Earthquake Test	0.24
7	Earthquake Test	0.26
8	Earthquake Test	0.28
9	Earthquake Test	0.30
10	Earthquake Test	0.32
11	Earthquake Test	0.34
12	Stop- collapse	0.36

Table 9. **Specimen B3:** Testing procedure

Testing date:28/12/2006

Test No.	Description	Nominal Acceleration (g)
1	Random	0.02
2	Earthquake Test	0.04
3	Earthquake Test	0.06
4	Earthquake Test	0.08
5	Earthquake Test	0.10
6	Earthquake Test	0.12
7	Earthquake Test	0.14
8	Earthquake Test	0.16
9	Earthquake Test	0.18
10	Earthquake Test	0.20
11	Earthquake Test	0.22
12	Earthquake Test	0.24
13	Earthquake Test	0.26

Table 10. **Specimen B4:** Testing procedure

Testing date:26/7/2007

Test No.	Description	Nominal Acceleration (g)
1	Random	0.02
2	Earthquake Test	0.04
3	Earthquake Test	0.06
4	Earthquake Test	0.08
5	Earthquake Test	0.10
6	Earthquake Test	0.12
7	Earthquake Test	0.14
8	Earthquake Test	0.16
9	Earthquake Test	0.18
10	Earthquake Test	0.20
11	Earthquake Test	0.22

## 5 Test Facility

The destructive earthquakes that occurred in the major cities of Greece during the period 1978-1981 gave a “support” for the construction of the shaking simulator at the Laboratory for Earthquake Engineering at National Technical University of Athens (LEE/NTUA). The establishment was totally funded from national sources. The simulator consists of a rigid platform with dimension 4.00 x 4.00m<sup>2</sup> with 6 degrees of freedom and of a system controlling the input motion and the response of the specimen tested on the platform. The facility has been manufactured by the American

Company MTS. The earthquake simulator was calibrated and became fully operational at the beginning of 1987.

The Laboratory for Earthquake Engineering belongs to the large-scale facilities of the European Commission since 1993. From 2000 the Laboratory was certified in accordance with TUV CERT procedures for its dynamic seismic tests according to EN ISO 9002:1994, while today is certified in accordance with EN ISO 9001:2002.

### 5.1 Location.

The address is:

Laboratory for Earthquake Engineering,  
National Technical University of Athens,  
Polytechnic Campus,  
Zografos 15700. Athens, Greece.

Tel.: 0030210-7721180 Fax 0030210-7721182

The access to the test facility is easy for long and large vehicles, since the facility is adjacent to a high way, and there is a large parking in front of it.

### 5.2 Test equipment description and calibration

#### **Platform-Mechanical Parts**

Dimensions: 4mx4mx6m

Weight :100 kN Material : Steel

Number of independent degrees of freedom: six (6)

Max weight of Specimen 100 kN, if centre of mass is at 2m above the simulator's platform. Larger specimen weights might be accommodated according to the calibration curves.

Max Horizontal Force (direction X,Y): 320 (kN) max Vertical Force (direction Z): 640 (kN) max Displacement of the platform each axis:  $\pm 10$  (cm)

Max rotation about each axis:  $7 \times 10^{-2}$  (rad)

Max acceleration to each horizontal Direction: (X,Y): 2.0 g max acceleration, to vertical direction (Z): 4.0 g

Max velocity to each axis: 100 cm/sec

Operating frequencies for each degree of freedom: 0.1- 50 Hz

Electric Power installed:1200 kVA

**Analogue Unit:** Specific analogue unit with which the user has the possibility of independent performance of each degree of freedom. The unit can produce and combine: sinusoidal, quadrangular etc vibrations for each direction simultaneously. External recordings of other receivers can be used to provide input to the analogue unit.**Digital Unit:** PC based digital unit. Possibility of exciting the platform with strong motion data stored in the computer, through D/A converters. The six degrees of

freedom can be excited simultaneously or independently. Creation of input signals with specified spectra or other characteristics. **Table Motion Control Software:** Waveform creation, Real-time test control, Control enhancement iteration, Table motion analysis, Library handling and Graphic display. **Data Acquisition System** with 64 channels is used for the attendance of dynamic phenomena from several receivers (Strain gauges, accelerometers, load cells, displacement transducers etc). **Storage of recorded signals - evaluation of signals:** The recorded data are immediately recorded after each test on hard disks, CD's or DVD's. Evaluation of input signals or specimen response records is done using the software libraries available at the Laboratory for Earthquake Engineering. Several functions are available which operate upon data in the time (digital filtering, differentiation, integration, extreme value, rms acceleration, total earthquake energy) or in frequency domain (Forward and inverse Fourier transformation, response spectrum, auto-spectral density, cross-spectral density, transfer function).

## 6 Reanalyzing of test results

### 6.1 Analysis of test data

In Appendix A to H all the recorded signals for each specimen are presented. More specifically the following data are shown:

1. Achieved table acceleration and displacement time histories.
2. Acceleration time histories along X direction.
3. Absolute displacements.
4. Relative displacements.

The time histories plots are not presented for some instruments when the recorded signals were too small (noise).

### 6.2 Damages

#### 6.2.1 Specimen A1 –Silicate Calcium optimised units

A series of uniaxial earthquake tests was carried out with the input acceleration to be scaled stepwise up to 0.16g. Seven tests were performed with base acceleration 0.04g, 0.06g, 0.08g, 0.10g, 0.12g, 0.14g and 0.16g. During test with base acceleration 0.14g, diagonal cracks appeared at the horizontal wall of 2<sup>nd</sup> level. During last tests, the diagonal cracks of horizontal wall of 2<sup>nd</sup> level were enlarged and diagonal cracks appeared at the horizontal wall of 1<sup>st</sup> level (Figure 24). Cracks also occurred at the transversal walls (T-shaped walls) of 1<sup>st</sup> and 2<sup>nd</sup> level (Figure 25). Out of plane movement of transversal walls was also observed, especially at the transversal wall of 2<sup>nd</sup> level (Figure 24-25).



Figure 24. **Specimen A1:** Diagonal cracks of 1<sup>st</sup> and 2<sup>nd</sup> level - in plane walls.



Figure 25. **Specimen A1:** Diagonal cracks of 1<sup>st</sup> and 2<sup>nd</sup> level in transversal wall, out of plane permanent displacement of wall at 2<sup>nd</sup> level.

### 6.2.2 Specimen A2 –Silicate Calcium optimised units with vertical perforation

A series of uniaxial earthquake tests was carried out with the input acceleration to be scaled stepwise up to 0.16g. Seven tests were performed with base acceleration 0.04g, 0.06g, 0.08g, 0.10g, 0.12g, 0.14g and 0.16g. During test with base acceleration 0.12g, vertical and horizontal cracks were appeared at the horizontal wall of 2<sup>nd</sup> level (Figure 26). From that test up to the last one, progressive damages were observed. At the end of tests the horizontal and vertical cracks of 2<sup>nd</sup> level in plane wall were enlarged, smaller cracks appeared at the horizontal wall of 1<sup>st</sup> level, while cracks appeared at the transversal wall of 2<sup>nd</sup> level which was moved out of plane (Figure 27).



Figure 26. **Specimen A2:** Horizontal and vertical cracks of 2<sup>nd</sup> level in plane wall.

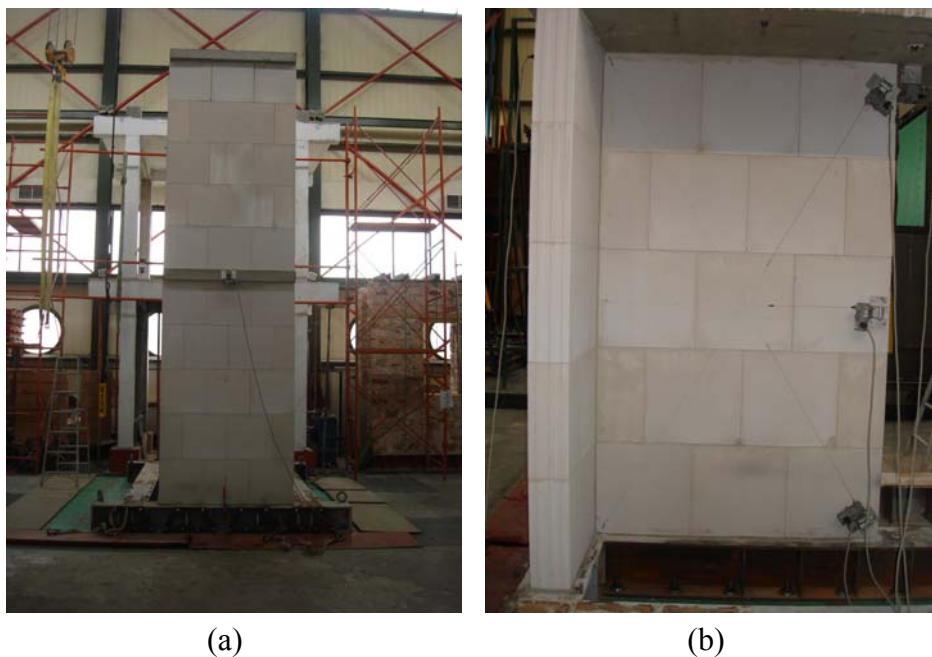

Figure 27. **Specimen A2:** (a): Cracks at the transversal wall of 2<sup>nd</sup> level- Out of plane movement, (b): Cracks at the 1<sup>st</sup> level in plane wall.

### 6.2.3 **Specimen A3** –Silicate Calcium optimised units with vertical perforation and vertical confinement.

A uniaxial earthquake test was carried out with the input acceleration of 0.02g. During this test the specimen had not been loaded with any additional mass. Out of plane movements of 2<sup>nd</sup> level transversal wall was observed (Figure 28). Then additional mass was decided to place on both 1<sup>st</sup> and 2<sup>nd</sup> level. The additional masses were placed directly on the slab of the 2<sup>nd</sup> level, while a steel grid was constructed on the slab of the 1<sup>st</sup> level, where the masses were placed. After the placement of additional masses, seven tests were performed with the input acceleration to be increased stepwise up to 0.16g. During these tests, the only damage that observed was again the out of plane displacement of transversal walls. Then wooden strips were

placed in order to restrain these movements and a series of earthquake tests were performed with the input acceleration to be increased stepwise up to 0.30g. In Figure 29 and 30 the damages at the end of testing are presented.



Figure 28. Specimen A3- without mass: Out of plane movements of transversal wall of 2<sup>nd</sup> level.



Figure 29. Specimen A3- with masses: Stepped cracks on transversal walls, permanent out of plane displacement.



Figure 30. Specimen A3- with masses: Crack at the interface between transversal and horizontal wall of T- shaped part, crushing of units, diagonal cracks on horizontal wall.



#### 6.2.4 Specimen B1 –Clay optimized units

A series of uniaxial earthquake tests was carried out with the input acceleration to be scaled stepwise up to 0.18g. Nine tests were performed with base acceleration 0.04g, 0.06g, 0.08g, 0.10g, 0.12g, 0.14g, 0.16g and 0.18g, which was repeated two times. sDuring test with base acceleration 0.14g, uplift occurred (crack at the base of lower horizontal wall). From that test up to the last one, progressive damages were observed. At the end of tests diagonal crack occurred at the horizontal and transversal wall of 1<sup>st</sup> level, while diagonal smaller cracks appeared at the horizontal wall of 2<sup>nd</sup> level (Figure 31).

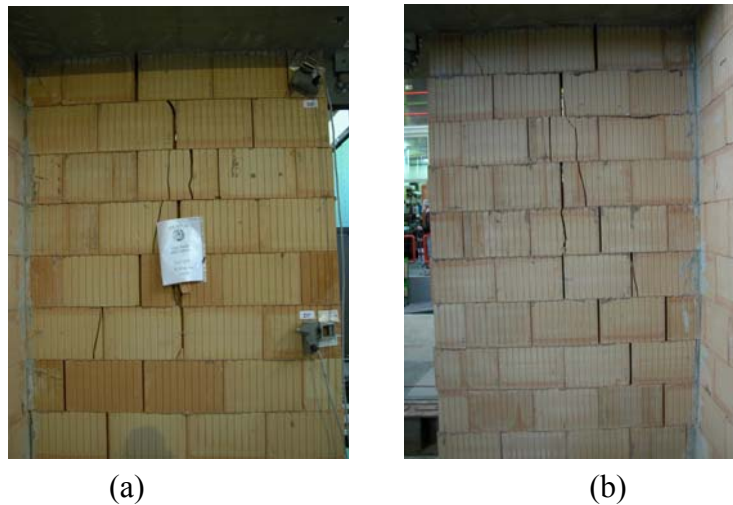

Figure 31. **Specimen B1:** Diagonal cracks of horizontal wall of 1<sup>st</sup> level (a) front view, (b) back view.

#### 6.2.5 Specimen B2 – First series of test- two story building - Clay units- Horizontal walls with clay infill blocks

A series of uniaxial earthquake was carried out with the input acceleration to be scaled stepwise up to 0.18g. Eight tests were performed with base acceleration 0.04g, 0.06g, 0.08g, 0.10g, 0.12g, 0.14g, 0.16g and 0.18g. During test with base acceleration 0.12g crushing of units of transversal wall of 2<sup>nd</sup> level was occurred. During test with base acceleration 0.14g a crack through the height of horizontal wall of 2<sup>nd</sup> level was occurred while the first layer of units at transversal wall closed to the plate of 2<sup>nd</sup> level was moved having permanent displacements. The last test (0.18g) stopped before its end. The two transversal walls of 2<sup>nd</sup> story moved out of plane, the plate of second floor moved from its initial position and the horizontal cracks enlarged (Figure 32).



Figure 32. **Specimen B2**- crack through the height of horizontal wall of 2<sup>nd</sup> level.

After the end of tests, it was decided to remove the second level (plate and walls) as the first level didn't suffer any damage from the first series of tests (Specimen B2\*\*). The one story specimen excited with the same uniaxial earthquake, starting from base acceleration 0.18g up to 0.36g. An uplift at the base of horizontal and transversal walls observed for base acceleration 0.20g. During tests 0.26g- 0.30g the plate suffered strong bending. Diagonal cracks appeared at the upper corner of horizontal wall for base acceleration 0.32g. At the end of tests partial collapse of horizontal wall, crushing of units, out of plane movement of transversal walls, diagonal cracks at all walls and permanent displacement of plate observed (Figure 33- 35).



Figure 33. **Specimen B2\*\***: Damage at the end of tests.



Figure 34. **Specimen B2\*\***: Cracks pattern of the transversal walls.



Figure 35. **Specimen B2\*\***: (a): Partial collapse of horizontal wall, (b): Permanent movement of plate.

#### 6.2.6 **Specimen B3** –Two story building - Clay units- Horizontal walls with clay infill blocks+ reinforcement

A series of uniaxial earthquake was carried out with the input acceleration to be scaled stepwise up to 0.26g. Seven tests were performed with base acceleration 0.04g, 0.06g, 0.08g, 0.10g, 0.12g, 0.14g and 0.16g without any damage on the specimen. During test with base acceleration 0.18g, cracking through the height of the horizontal wall of 1<sup>st</sup> level occurred (Figure 36). The crack passed through the clay units perpendicular to the holes. Progressive damages were observed during test with base acceleration 0.20g, 0.22g, while during test with base acceleration 0.24g, a crack in the opposite direction similar to the first one, appeared through the height of the horizontal wall of 1<sup>st</sup> level. During last test with base acceleration 0.26g, the wall of

1<sup>st</sup> level partially collapsed and permanent movement of the 1<sup>st</sup> level slab (Figures 37, 38) observed.

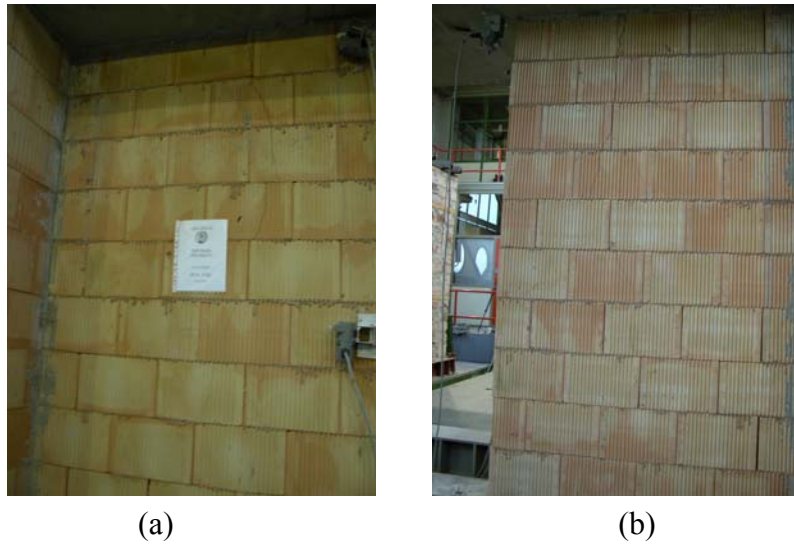

Figure 36. **Specimen B3**: Test 0.18g: Cracking through the height of 1<sup>st</sup> horizontal wall the crack appeared perpendicular to the holes of clay units (a) front view, (b) back view.

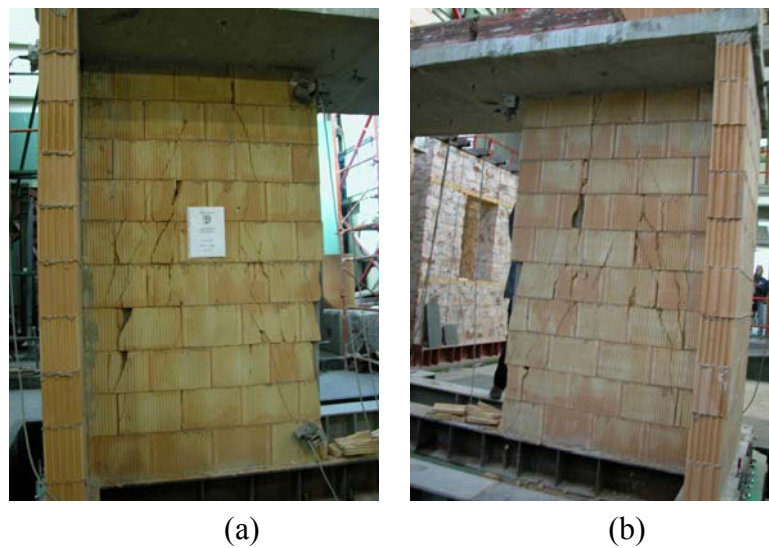

Figure 37. **Specimen B3**: Test 0.26g: Cracking through the height of 1<sup>st</sup> horizontal wall, partial collapse (a) front view, (b) back view.



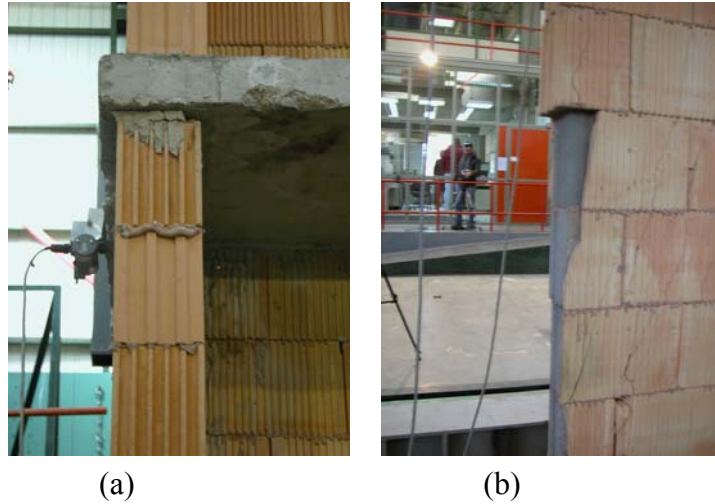

Figure 38. **Specimen B3:** Test 0.26g: Cracking through the height of 1<sup>st</sup> horizontal wall, partial collapse (a) movement of the slab of 1<sup>st</sup> level, (b) crushing of clay units.

#### 6.2.7 Specimen B4 –Two story building – Lightweight aggregate concrete blocks

A series of uniaxial earthquake was carried out with the input acceleration to be scaled stepwise up to 0.22g. Seven tests were performed with base acceleration 0.04g, 0.06g, 0.08g, 0.10g, 0.12g, 0.14g and 0.16g without any damage on the specimen. During test with base acceleration 0.18g, cracking through the height of the horizontal wall of 1<sup>st</sup> level occurred (Figure 39). The crack passed through the concrete blocks. During last test with base acceleration 0.22g, separation at the interface between transversal and horizontal wall of T- shaped part and crushing of the blocks at 1<sup>st</sup> level (Figure 39) observed.



Figure 39. **Specimen B4:** Test 0.22g: Cracking through the height of 1<sup>st</sup> level horizontal wall, crushing of lightweight concrete blocks and separation between transversal and horizontal wall of T- shaped part.

### 6.3 Acceleration Amplification Factor

The acceleration amplification factor is computed for each specimen for strong tests. The acceleration amplification factor is given dividing the maximum acceleration response at each level by the effective acceleration of input acceleration. The effective acceleration is defined as the maximum value of the acceleration signal that has been filtered with a low pass filter of 10Hz (The frequency range of acceleration base signal is up to 10Hz). The amplification factor is computed for each level. In Tables 11 to 18 the amplification factors are presented for each specimen, while in Figures 40 and 47 the amplification factor is plotted versus effective acceleration for each specimen. Response acceleration time histories were corrected in order to remove the part of acceleration signal that is caused due to rocking of specimen after cracking. The amplification factor is computed using corrected response acceleration signals

Table 11. **Specimen A1: Acceleration Amplification factors.**

Test	Effective Acceleration (m/sec <sup>2</sup> )	1 <sup>st</sup> Level A1X (m/sec <sup>2</sup> )	2 <sup>nd</sup> Level A2X (m/sec <sup>2</sup> )	Amplification Factor	
				1 <sup>st</sup> Level	2 <sup>nd</sup> Level
4	0.97	1.59	2.35	1.64	2.42
5	1.22	2.06	3.24	1.69	2.66
6	1.45	2.91	5.01	2.01	3.46
7	1.67	5.21	5.1	3.12	3.05
8	1.96	3.37	5.81	1.72	2.96

Table 12. **Specimen A2: Acceleration Amplification factors.**

Test	Effective Acceleration (m/sec <sup>2</sup> )	1 <sup>st</sup> Level A1X (m/sec <sup>2</sup> )	2 <sup>nd</sup> Level A2X (m/sec <sup>2</sup> )	Amplification Factor	
				1 <sup>st</sup> Level	2 <sup>nd</sup> Level
4	0.97	2.08	2.97	2.14	3.06
5	1.23	2.31	2.99	1.88	2.43
6	1.46	2.56	4.01	1.75	2.75
7	1.72	5.48	6.22	3.19	3.62
8	1.94	5.66	5.29	2.92	2.73

Table 13. **Specimen A3: Acceleration Amplification factors.**

Test	Effective Acceleration (m/sec <sup>2</sup> )	1 <sup>st</sup> Level A1X (m/sec <sup>2</sup> )	2 <sup>nd</sup> Level A2X (m/sec <sup>2</sup> )	Amplification Factor	
				1 <sup>st</sup> Level	2 <sup>nd</sup> Level
12	0.51	0.85	1.53	1.67	3.00
13	0.98	1.64	2.68	1.677	2.73
17	2.49	3.57	6.11	1.437	2.45
18	2.87	5.5	7.96	1.92	2.77
19	3.39	7.75	9.21	2.27	2.72
20	3.56	6.03	10.73	1.69	3.01

Table 14. **Specimen B1: Acceleration Amplification factors.**

Test	Effective Acceleration (m/sec <sup>2</sup> )	1 <sup>st</sup> Level A1X (m/sec <sup>2</sup> )	2 <sup>nd</sup> Level A2X (m/sec <sup>2</sup> )	Amplification Factor	
				1 <sup>st</sup> Level	2 <sup>nd</sup> Level
5	1.22	1.98	3.23	1.62	2.65
6	1.52	3.27	3.85	2.15	2.53
7	1.76	4.08	4.66	2.32	2.65
8	1.92	5.46	6.37	2.84	3.32
9	2.18	4.43	6.05	2.03	2.78

Table 15. **Specimen B2: Acceleration Amplification factors.**

Test	Effective Acceleration (m/sec <sup>2</sup> )	1 <sup>st</sup> Level A1X (m/sec <sup>2</sup> )	2 <sup>nd</sup> Level A2X (m/sec <sup>2</sup> )	Amplification Factor	
				1 <sup>st</sup> Level	2 <sup>nd</sup> Level
5	1.24	2.36	3.14	1.90	2.53
6	1.48	2.76	3.72	1.86	2.51
7	1.73	3.72	5.17	2.15	2.99
8	2.01	5.16	7.83	2.57	3.90
9	stop	-	-	-	-

Table 16. **Specimen B2\*\*:** Acceleration Amplification factor.

Test	Effective Acceleration (m/sec <sup>2</sup> )	1 <sup>st</sup> Level A1X (m/sec <sup>2</sup> )	Amplification Factor 1 <sup>st</sup> Level
5	2.25	7.63	3.39
6	2.32	8.73	3.76
7	2.68	9.66	3.60
8	2.81	8.28	2.95
9	2.97	8.72	2.94
10	3.24	10.91	3.37
11	3.42	14.14	4.13
12	stop	-	-

Table 17. **Specimen B3: Acceleration Amplification factors.**

Test	Effective Acceleration (m/sec <sup>2</sup> )	1 <sup>st</sup> Level A1X (m/sec <sup>2</sup> )	2 <sup>nd</sup> Level A2X (m/sec <sup>2</sup> )	Amplification Factor	
				1 <sup>st</sup> Level	2 <sup>nd</sup> Level
5	1.22	2.09	2.78	1.71	2.28
6	1.42	2.69	3.71	1.89	2.61
7	1.67	2.72	4.3	1.63	2.57
8	1.91	3.71	4.41	1.94	2.31
9	2.14	3.35	4.71	1.57	2.20
10	2.44	4.5	6.15	1.84	2.52
11	2.71	5.01	6.96	1.85	2.57
12	2.97	4.91	6.46	1.65	2.18
13	3.13	5.24	6.62	1.67	2.12

Table 18. **Specimen B4: Acceleration Amplification factors.**

Test	Effective Acceleration (m/sec <sup>2</sup> )	1 <sup>st</sup> Level A1X (m/sec <sup>2</sup> )	2 <sup>nd</sup> Level A2X (m/sec <sup>2</sup> )	Amplification Factor	
				1 <sup>st</sup> Level	2 <sup>nd</sup> Level
2	0.46	0.98	2.58	2.13	5.61
4	0.99	1.7	2.43	1.72	2.45
5	1.22	2.36	4.07	1.93	3.34
6	1.47	2.44	5.88	1.66	4.00
7	1.69	2.8	5.6	1.66	3.31
8	1.95	4.49	8.05	2.30	4.13
9	2.15	4.38	6.69	2.04	3.11
10	2.32	6.39	11.27	2.75	4.86
11	2.64	6.95	11.27	2.63	4.27

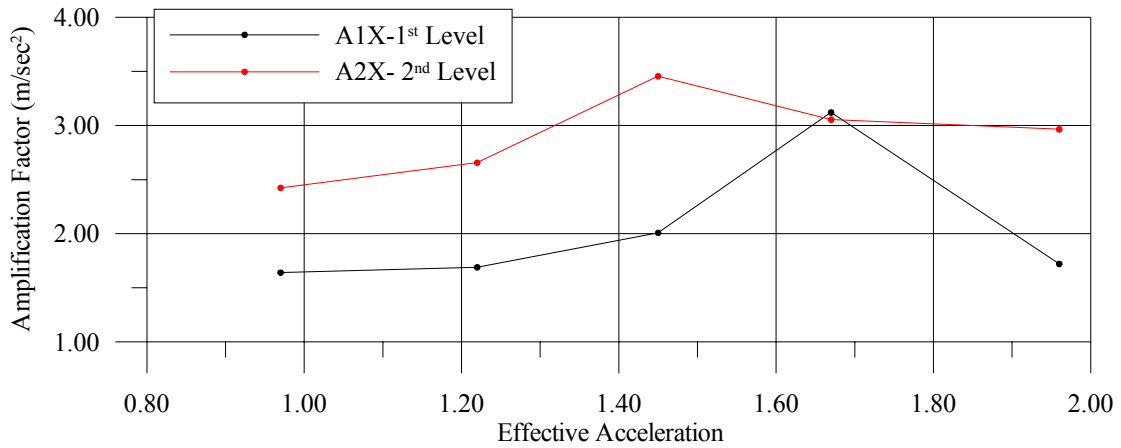

Figure 40. **Specimen A1: Amplification factor versus effective input acceleration.**

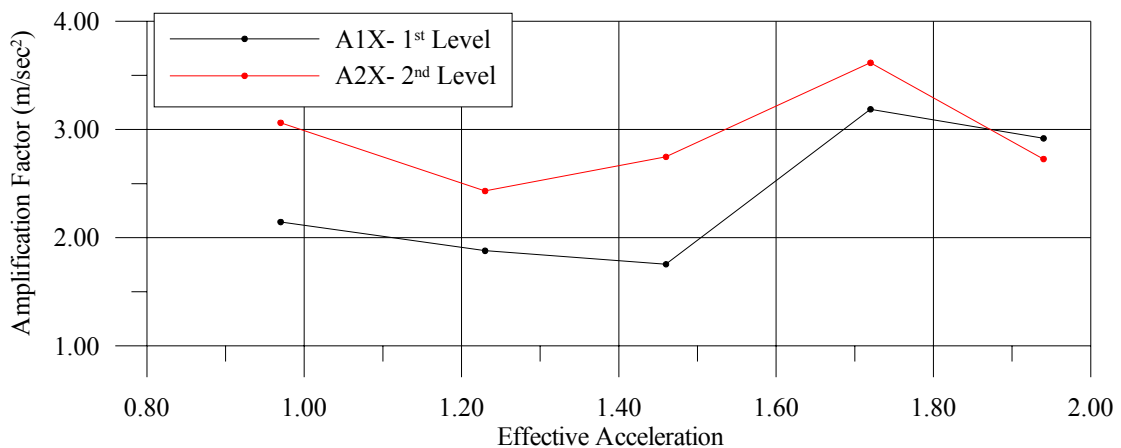

Figure 41. **Specimen A2: Amplification factor versus effective input acceleration.**



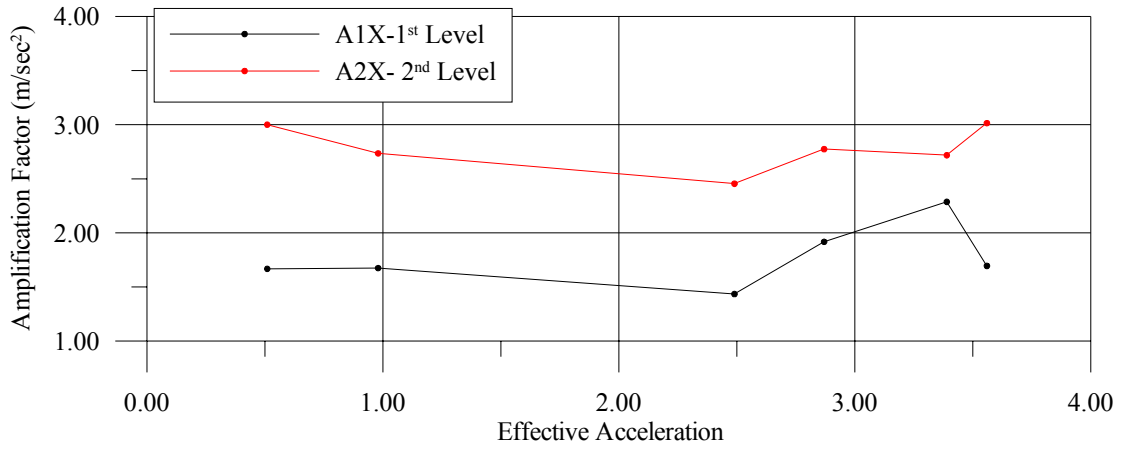

Figure 42. **Specimen A3:** Amplification factor versus effective input acceleration.

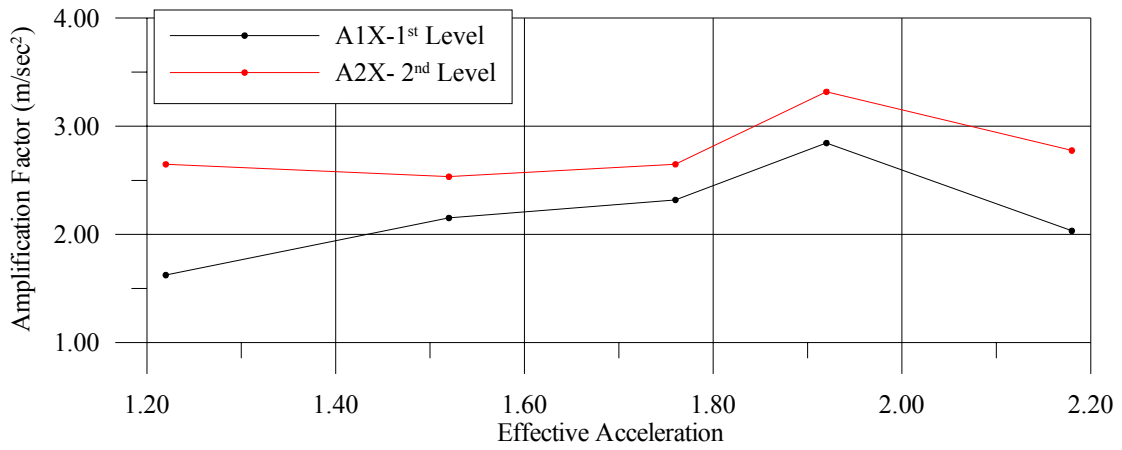

Figure 43. **Specimen B1:** Amplification factor versus effective input acceleration.

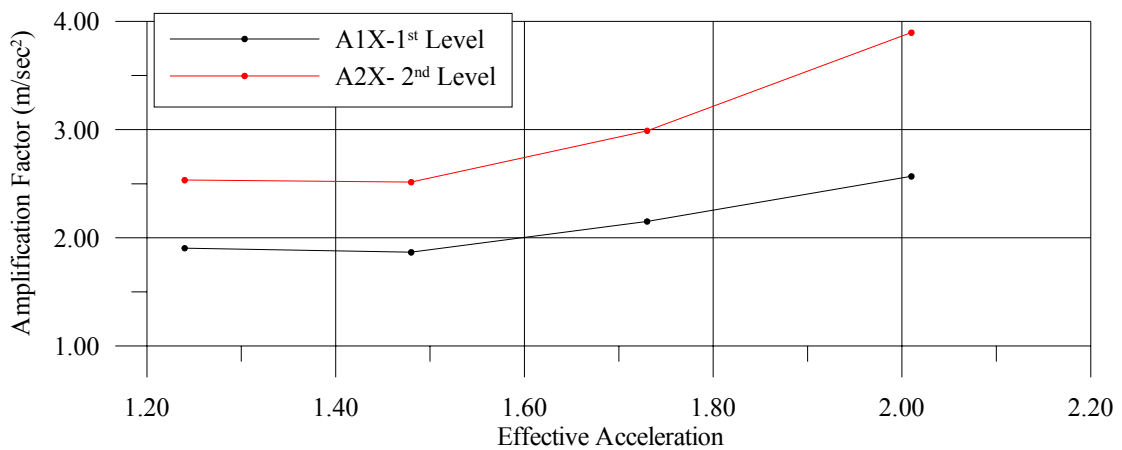

Figure 44. **Specimen B2:** Amplification factor versus effective input acceleration.

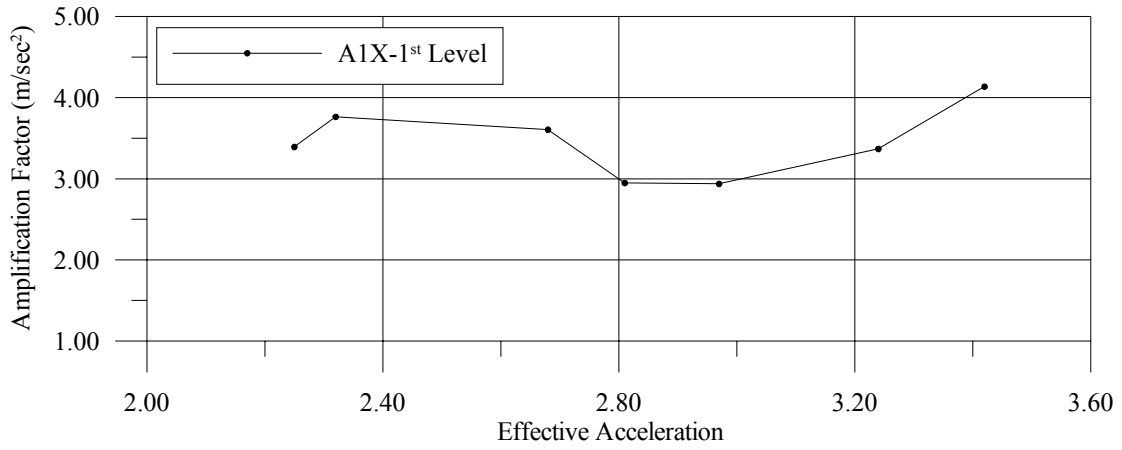

Figure 45. **Specimen B2\*\*:** Amplification factor versus effective input acceleration.

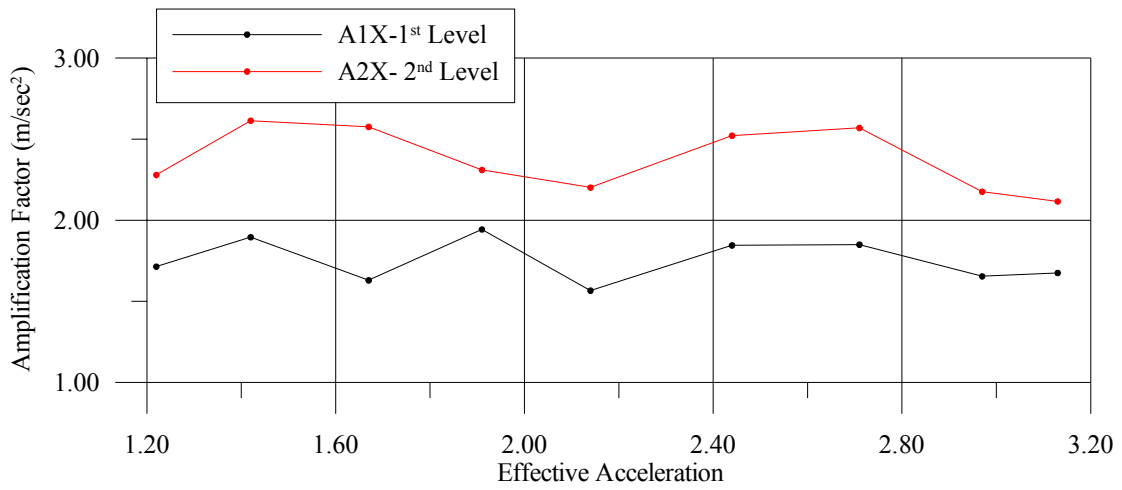

Figure 46. **Specimen B3:** Amplification factor versus effective input acceleration.

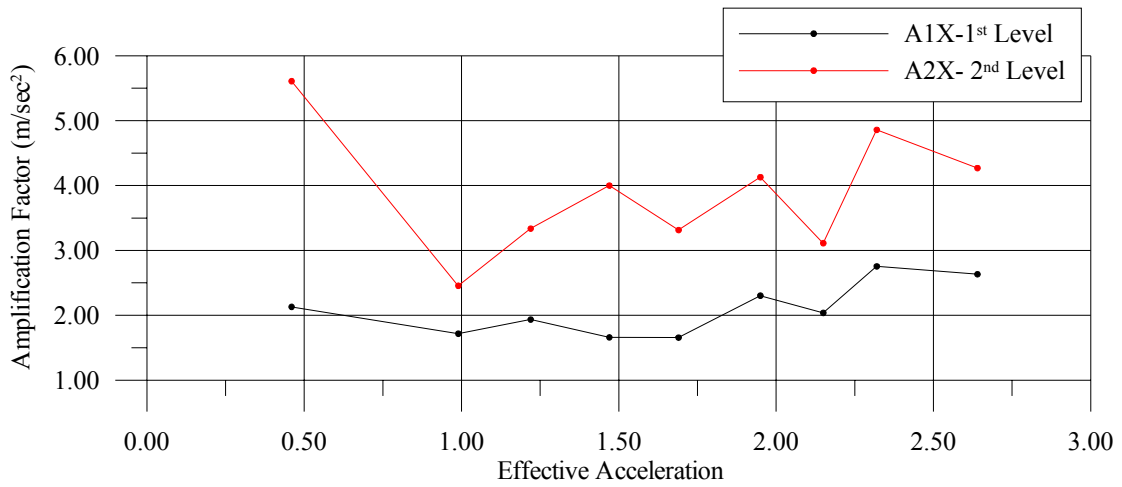

Figure 47. **Specimen B4:** Amplification factor versus effective input acceleration.

## 6.4 Hysteretic loops

Diagrams of base shear versus top relative displacement for low input acceleration as well for strong earthquake tests are shown in Figures 48 to 55 for all specimens. The shear for each level was calculated from the corresponding acceleration using the mass of each level, which is given as:

Mass of 2<sup>nd</sup> Level= top plate plus one half of 2<sup>nd</sup> level plus additional mass

Mass of 1<sup>st</sup> Level= top plate plus one half of 2<sup>nd</sup> level plus one half of 1<sup>st</sup> level plus additional mass

In Table 19 the mass for calculating shear forces for each specimen is given. The base shear is the sum of shear at each level. In Tables 20- 27 the maximum base shear / relative top displacement is given for all specimens for strong earthquake tests. Response acceleration and displacement signals were corrected in order to remove the part of signal that is caused due to the rocking of specimen after cracking.

Table 19. Mass for calculating shear forces.

Specimen	Additional Mass (Mgr)	
	1 <sup>st</sup> Level	2 <sup>nd</sup> Level
A1	8.53	7.33
A2	8.53	7.33
A3*	12.03	3.33
B1	6.63	6.38
B2	8.90	7.51
B2**	7.01	-
B3	8.90	7.51
B4	8.32	7.24

\* with additional mass, \*\* one-story specimen

Table 20. **Specimen A1:** Maximum base shear/ maximum relative displacements.

Test No./ Nominal Acceleration	Min/Max	A1X (m/sec <sup>2</sup> )	A2X (m/sec <sup>2</sup> )	1 <sup>st</sup> Level Relative displacement (mm)	2 <sup>nd</sup> Level Relative displacement (mm)	Base Shear (kN)
2/0.04g	Min	-0.67	-1.33	-1.55	-2.21	-10.93
	Max	0.56	1.34	1.19	1.77	14.29
4/0.08g	Min	-1.21	-2.08	-3.20	-7.63	-19.15
	Max	1.01	1.62	2.97	5.16	25.62
6/0.12g	Min	-1.80	-3.09	-5.27	-15.53	-21.45
	Max	1.59	1.94	4.40	7.09	29.89
7/0.14g	Min	-2.60	-3.24	-7.42	-25.94	-22.40
	Max	2.36	1.94	7.35	16.71	36.18
8/0.16g	Min	-2.57	-3.55	-12.48	-34.04	-24.73
	Max	2.20	1.99	11.37	25.32	35.39

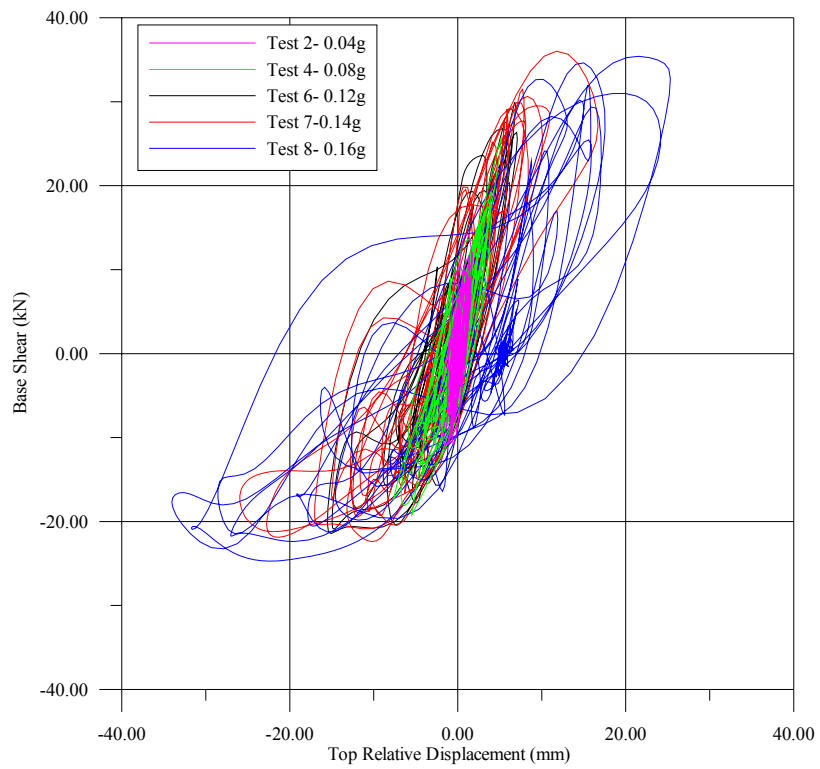

Figure 48. **Specimen A1:** Base shear - top relative displacement interaction diagram.

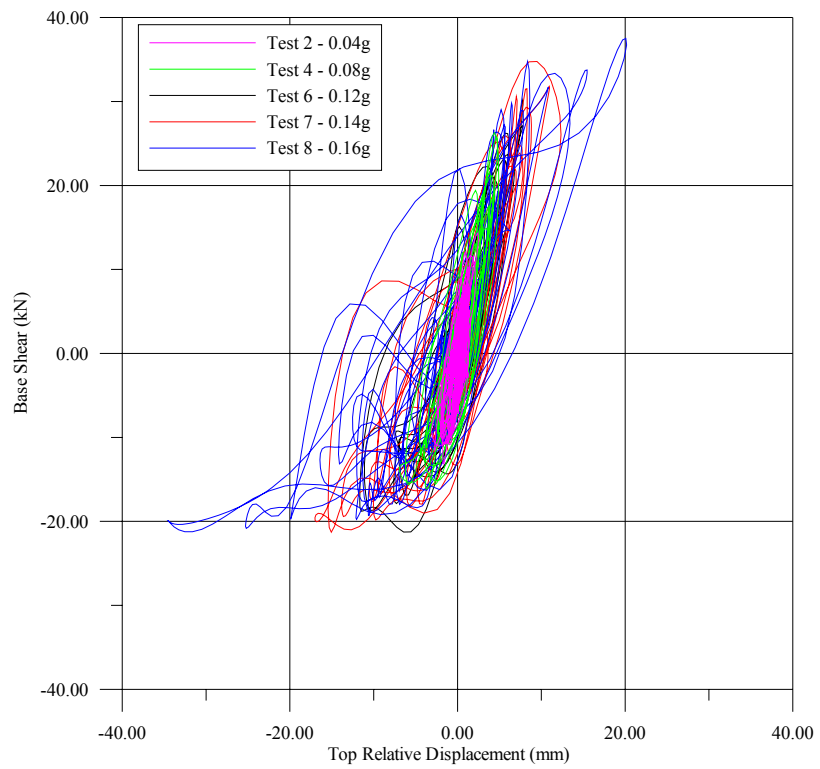

Figure 49. **Specimen A2:** Base shear - top relative displacement interaction diagram.

Table 21. **Specimen A2:** Maximum base shear/ maximum relative displacements.

Test No/ Nominal Acceleration	Min/Max	A1X (m/sec <sup>2</sup> )	A2X (m/sec <sup>2</sup> )	1 <sup>st</sup> Level Relative displacement (mm)	2 <sup>nd</sup> Level Relative displacement (mm)	Base Shear (kN)
2/0.04g	Min	-0.72	1.25	-1.74	3.03	13.18
	Max	0.60	1.20	2.13	2.53	14.30
4/0.08g	Min	-1.58	-2.16	-7.11	-6.91	-16.15
	Max	1.07	1.76	3.66	4.94	26.28
6/0.12g	Min	-1.79	-2.62	-9.43	-11.67	-21.28
	Max	1.39	1.74	6.86	7.83	30.13
7/0.14g	Min	-2.47	-3.01	-15.53	-16.99	-21.29
	Max	2.11	1.98	10.31	12.37	34.76
8/0.16g	Min	-2.44	-3.69	-8.94	-34.53	-21.24
	Max	2.70	2.08	7.75	20.18	37.51

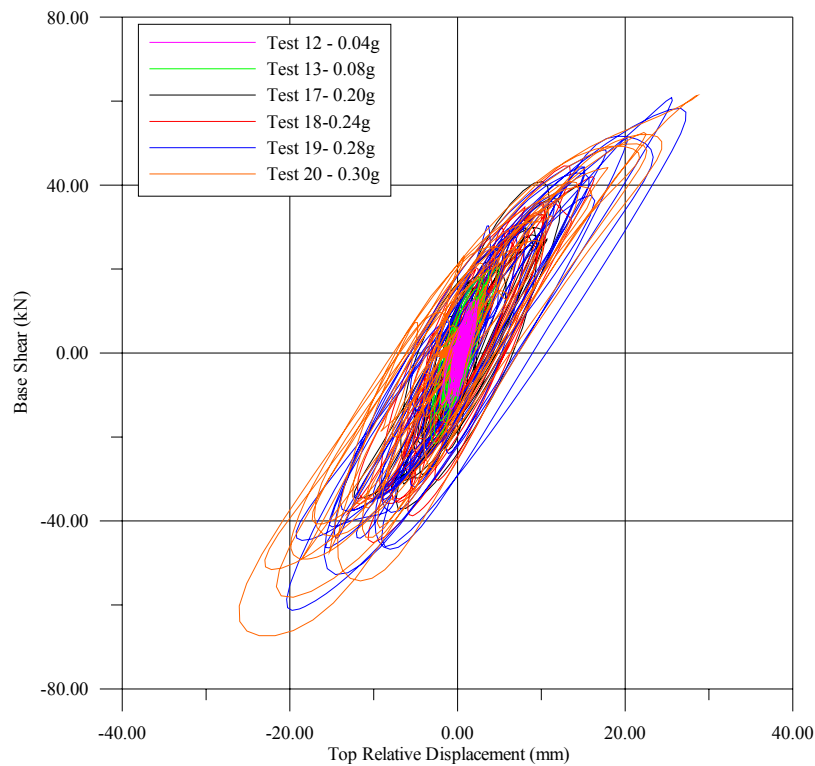

Figure 50. **Specimen A3:** Base shear - top relative displacement interaction diagram.

Table 22. **Specimen A3:** Maximum base shear/ maximum relative displacements.

Test No/ Nominal Acceleration	Min/Max	A1X (m/sec <sup>2</sup> )	A2X (m/sec <sup>2</sup> )	1 <sup>st</sup> Level Relative displacement (mm)	2 <sup>nd</sup> Level Relative displacement (mm)	Base Shear (kN)
12/0.04g	Min	-0.76	-1.24	-1.01	-2.02	-13.39
	Max	0.73	1.37	2.44	2.56	12.73
13/0.08g	Min	-1.22	-1.99	-1.59	-3.17	-21.57
	Max	1.26	2.17	2.97	5.00	10.43
17/0.20g	Min	-2.28	-4.34	-5.34	-12.32	-37.02
	Max	2.10	5.72	7.64	14.64	40.82
18/0.24g	Min	-2.53	-5.53	-6.32	-13.08	-45.18
	Max	2.38	6.34	8.75	16.33	44.55
19/0.28g	Min	-3.39	-7.33	-10.36	-20.37	-61.29
	Max	3.96	6.52	14.64	27.25	60.85
20/0.30g	Min	-3.70	-9.45	-12.24	-26.01	-67.33
	Max	4.61	8.07	15.83	28.67	61.35

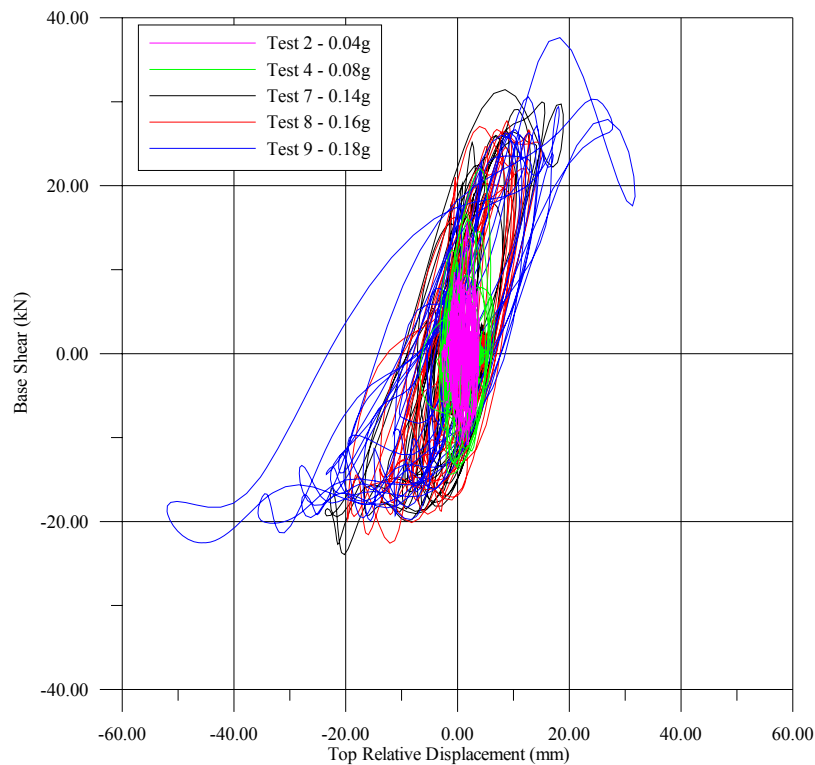

Figure 51. **Specimen B1:** Base shear - top relative displacement interaction diagram.

Table 23. **Specimen B1:** Maximum base shear/ maximum relative displacements.

Test No Nominal Acceleration	Min/Max	A1X (m/sec <sup>2</sup> )	A2X (m/sec <sup>2</sup> )	1 <sup>st</sup> Level Relative displacement (mm)	2 <sup>nd</sup> Level Relative displacement (mm)	Base Shear (kN)
2/0.04g	Min	-0.83	-1.65	-0.68	-2.69	-10.90
	Max	0.58	1.22	4.10	3.87	15.25
4/0.08g	Min	-1.28	-2.13	-3.81	-6.68	-14.40
	Max	0.96	1.74	5.56	6.59	22.04
7/0.14g	Min	-2.30	-2.87	-10.55	-23.66	-23.94
	Max	1.73	2.29	9.96	18.95	31.43
8/0.16g	Min	-2.36	-2.76	-11.63	-19.66	-22.60
	Max	2.33	2.24	9.83	15.03	27.71
9/0.18g	Min	-3.74	-3.32	-27.72	-51.96	-22.53
	Max	2.17	2.27	18.46	31.80	37.65

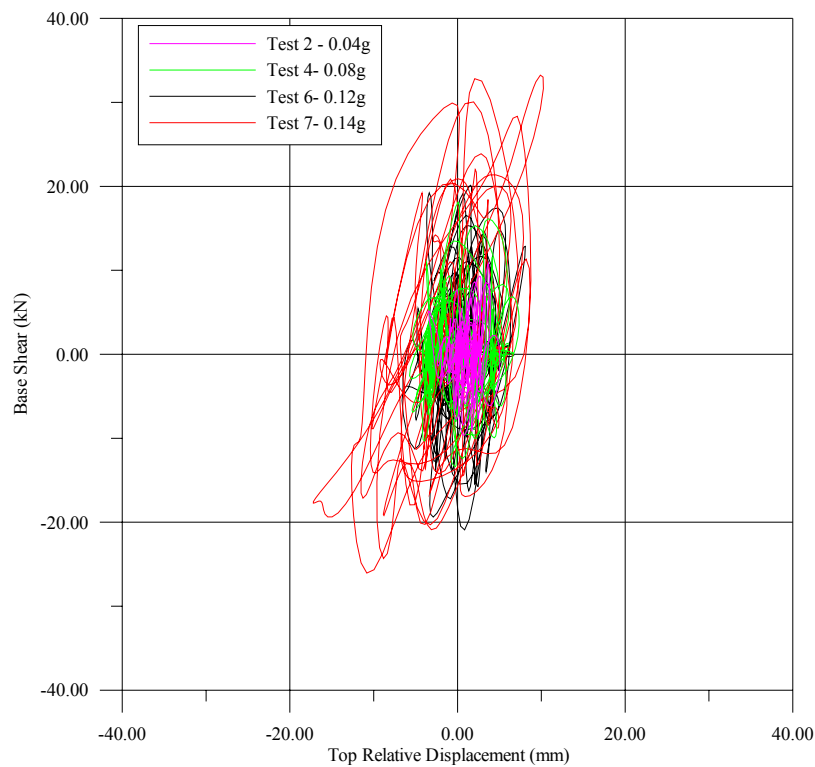

Figure 52. **Specimen B2:** Base shear - top relative displacement interaction diagram - Test 8 (0.16g)-Crack at upper horizontal wall- partial collapse.

Table 24. **Specimen B2**: Maximum base shear/ maximum relative displacements.

Test No/ Nominal Acceleration	Min/Max	A1X (m/sec <sup>2</sup> )	A2X (m/sec <sup>2</sup> )	1 <sup>st</sup> Level Relative displacement (mm)	2 <sup>nd</sup> Level Relative displacement (mm)	Base Shear (kN)
2/0.04g	Min	-0.79	-1.12	-1.03	-3.43	-9.62
	Max	0.57	0.91	2.84	5.07	10.84
4/0.08g	Min	-1.47	-1.82	-3.31	-6.83	-13.38
	Max	0.89	1.37	5.99	6.86	18.10
6/0.12g	Min	-1.82	-2.46	4.67	-6.60	-20.91
	Max	1.35	1.93	6.73	8.10	20.13
7/0.14g	Min	-2.24	-2.85	-6.79	-17.18	-26.04
	Max	1.63	1.74	6.55	10.26	33.25

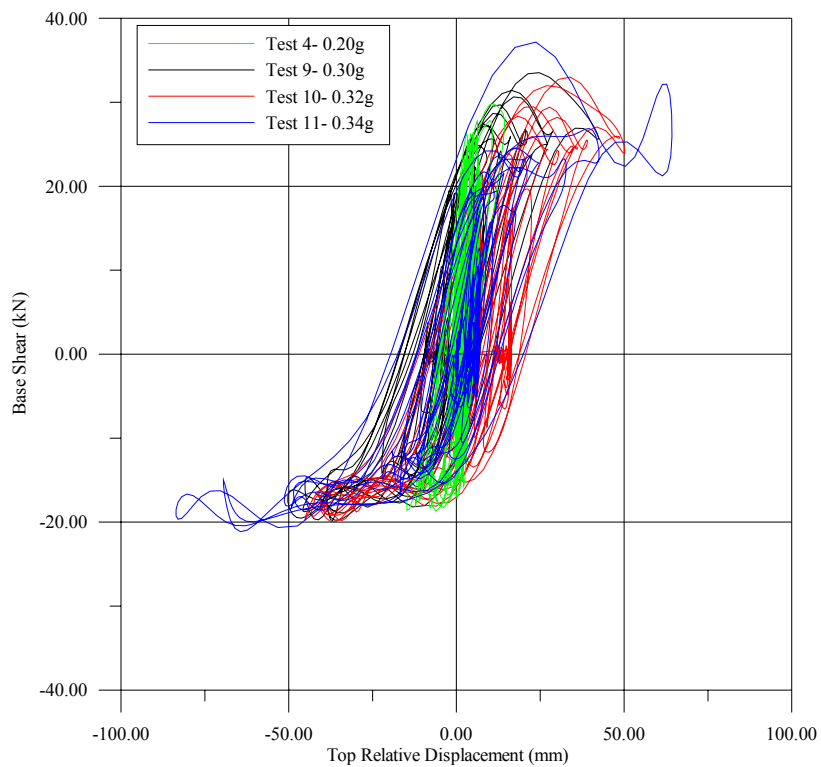

Figure 53. **Specimen B2\*\***: Base shear - top relative displacement interaction diagram - Test 12 (0.36g)- Collapse.



Table 25. **Specimen B2\*\***: Maximum base shear/ maximum relative displacements

Test No	Min/Max	A1X (m/sec <sup>2</sup> )	1 <sup>st</sup> Level Relative displacement (mm)	Base Shear (kN)
4	Min	-4.25	-14.77	-29.81
	Max	2.67	14.36	18.71
9	Min	-4.78	-50.24	-19.79
	Max	2.82	42.46	33.53
10	Min	-4.70	-45.14	-19.96
	Max	2.85	50.30	32.98
11	Min	-5.30	-83.53	-21.13
	Max	3.01	64.34	37.16

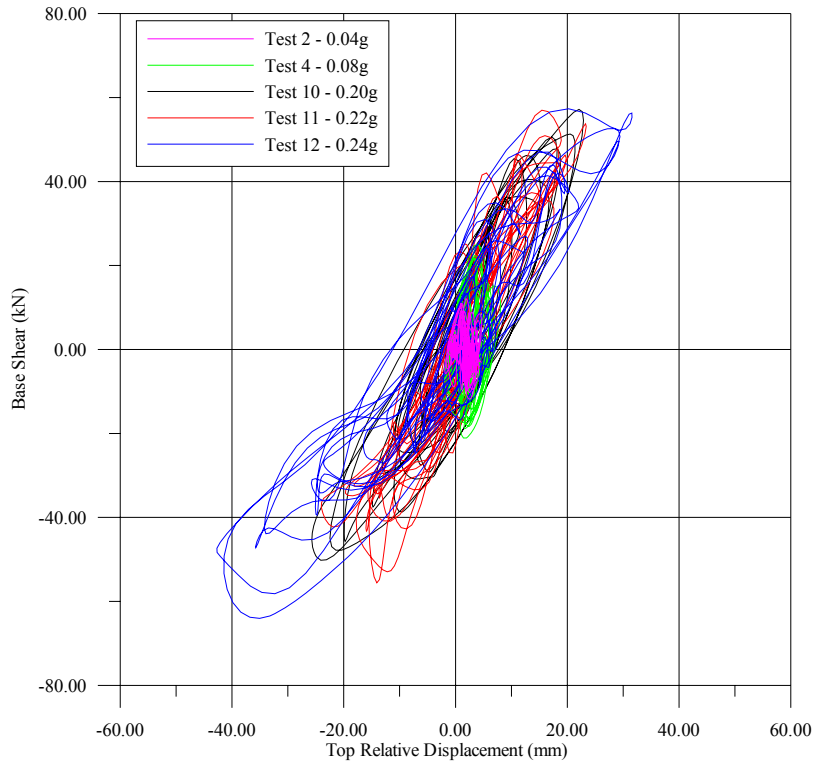

Figure 54. **Specimen B3**: Base shear - top relative displacement interaction diagram - Test 13 (0.26g)-collapse.

Table 26. **Specimen B3:** Maximum base shear/ maximum relative displacements.

Test No/ Nominal Acceleration	Min/Max	A1X (m/sec <sup>2</sup> )	A2X (m/sec <sup>2</sup> )	1 <sup>st</sup> Level Relative displacement (mm)	2 <sup>nd</sup> Level Relative displacement (mm)	Base Shear (kN)
2/0.04g	Min	-0.56	-0.98	-0.94	-1.91	-11.91
	Max	0.56	0.93	4.59	4.70	12.09
4/0.08g	Min	-1.18	-2.03	-2.11	-2.25	-21.06
	Max	0.96	1.90	6.18	8.04	25.10
10/0.20g	Min	-2.84	-4.64	-11.42	-25.62	-50.18
	Max	2.38	4.15	13.70	22.95	57.17
11/0.22g	Min	-3.21	-4.45	-14.31	-23.97	-55.57
	Max	3.29	3.84	16.83	23.42	57.00
12/0.24g	Min	-3.72	-5.03	-23.41	-42.67	-64.05
	Max	3.56	4.79	20.82	31.63	57.32

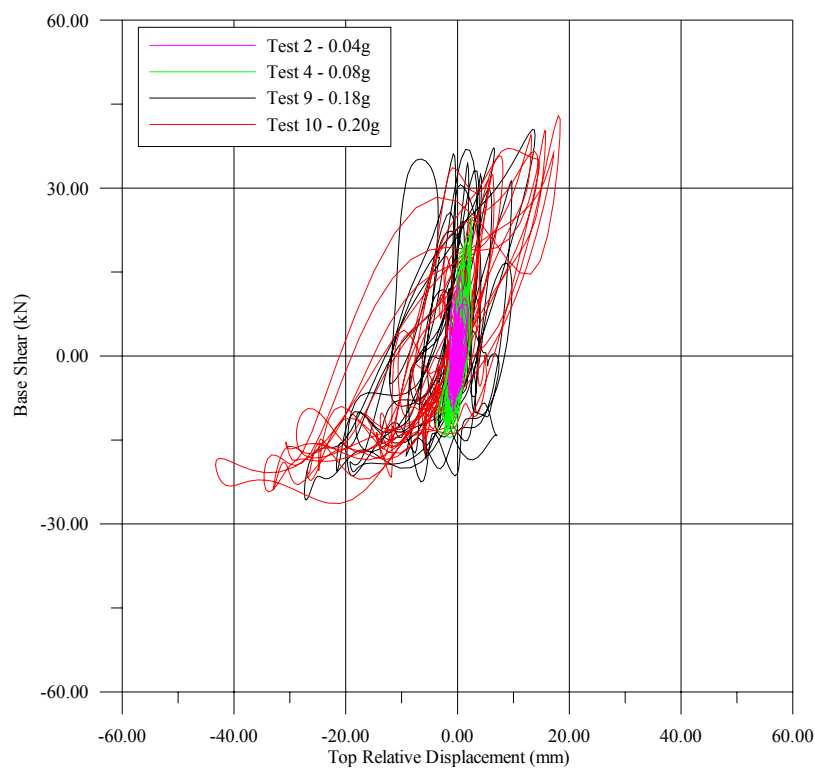

Figure 55. **Specimen B4:** Base shear - top relative displacement interaction diagram.

Table 27. **Specimen B4: Maximum base shear/ maximum relative displacements.**

Test No/ Nominal Acceleration	Min/Max	A1X (m/sec <sup>2</sup> )	A2X (m/sec <sup>2</sup> )	1 <sup>st</sup> Level Relative displacement (mm)	2 <sup>nd</sup> Level Relative displacement (mm)	Base Shear (kN)
2/0.04g	Min	-0.59	-1.40	-1.64	-1.68	-9.96
	Max	0.53	1.01	2.62	2.01	14.46
4/0.08g	Min	-1.23	-2.04	-0.70	-3.73	-14.59
	Max	0.86	1.60	3.70	2.62	24.76
9/0.18g	Min	-2.07	-3.48	-15.15	-27.37	-25.73
	Max	1.98	2.21	9.73	13.92	40.48
10/0.20g	Min	-3.09	-4.09	-17.76	-43.25	-26.91
	Max	2.45	2.46	10.28	18.40	42.91

## 6.5 Story drift

The story drift of 1<sup>st</sup> level is computed by dividing the relative displacement of 1<sup>st</sup> level by its height, while the story drift of 2<sup>nd</sup> level is given by dividing the difference between relative displacements of 1<sup>st</sup> and 2<sup>nd</sup> level by the height of 2<sup>nd</sup> story. In Tables 28 to 35 the story drift is given for each specimen for low input acceleration and strong earthquake tests. In Figures 56 to 63 the time history of 1<sup>st</sup> and 2<sup>nd</sup> story drift of each specimen is presented for strong earthquake tests.

Table 28. **Specimen A1: Story drift of 1<sup>st</sup> and 2<sup>nd</sup> Level.**

Test No	Min/Max	1 <sup>st</sup> Level Story drift (‰)	2 <sup>nd</sup> Level Story drift (‰)
4	Min	-1.28	-1.74
	Max	1.19	1.12
6	Min	-2.11	-4.43
	Max	1.76	1.44
7	Min	-2.97	-7.97
	Max	2.94	4.00
8	Min	-4.99	-10.72
	Max	4.54	7.28

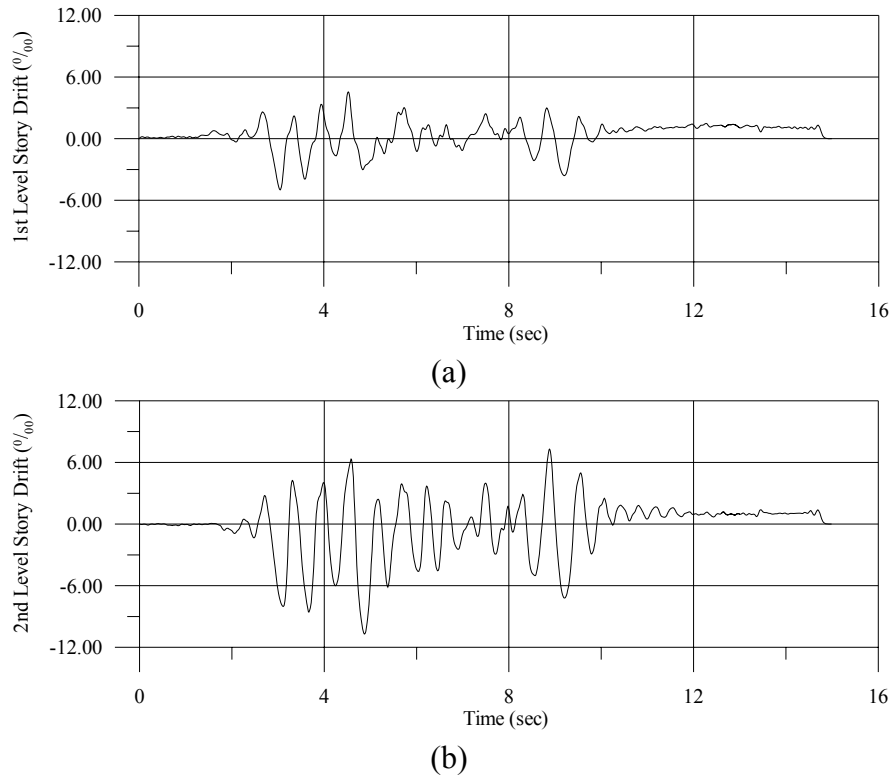

Figure 56. Specimen A1- Story drift time history Test 8: (a): 1<sup>st</sup> level, (b): 2<sup>nd</sup> Level.

Table 29. Specimen A2: Story drift of 1<sup>st</sup> and 2<sup>nd</sup> Level.

Test No	Min/Max	1 <sup>st</sup> Level Story drift (‰)	2 <sup>nd</sup> Level Story drift (‰)
4	Min	-2.85	-0.62
	Max	1.46	0.98
6	Min	-3.77	-1.27
	Max	2.71	1.14
7	Min	-6.21	-1.19
	Max	4.13	1.15
8	Min	-3.58	-11.30
	Max	3.10	5.24

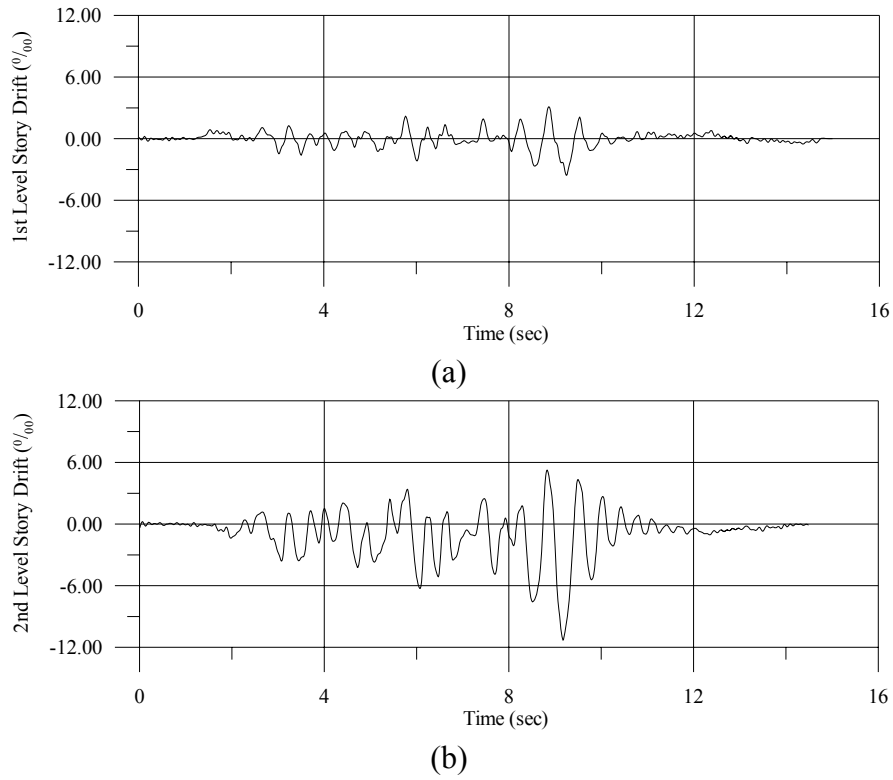

Figure 57. Specimen A2- Story drift time history Test 8: (a): 1<sup>st</sup> level, (b): 2<sup>nd</sup> Level.

Table 30. Specimen A3: Story drift of 1<sup>st</sup> and 2<sup>nd</sup> Level.

Test No	Min/Max	1 <sup>st</sup> Level Story drift (‰)	2 <sup>nd</sup> Level Story drift (‰)
12	Min	-0.40	-1.02
	Max	0.97	0.55
13	Min	-0.64	1.07
	Max	1.19	1.24
17	Min	-2.14	-2.81
	Max	3.06	2.88
18	Min	-2.53	-3.00
	Max	3.50	3.03
19	Min	-4.15	-4.02
	Max	5.86	5.11
20	Min	-4.90	-5.64
	Max	6.33	5.13

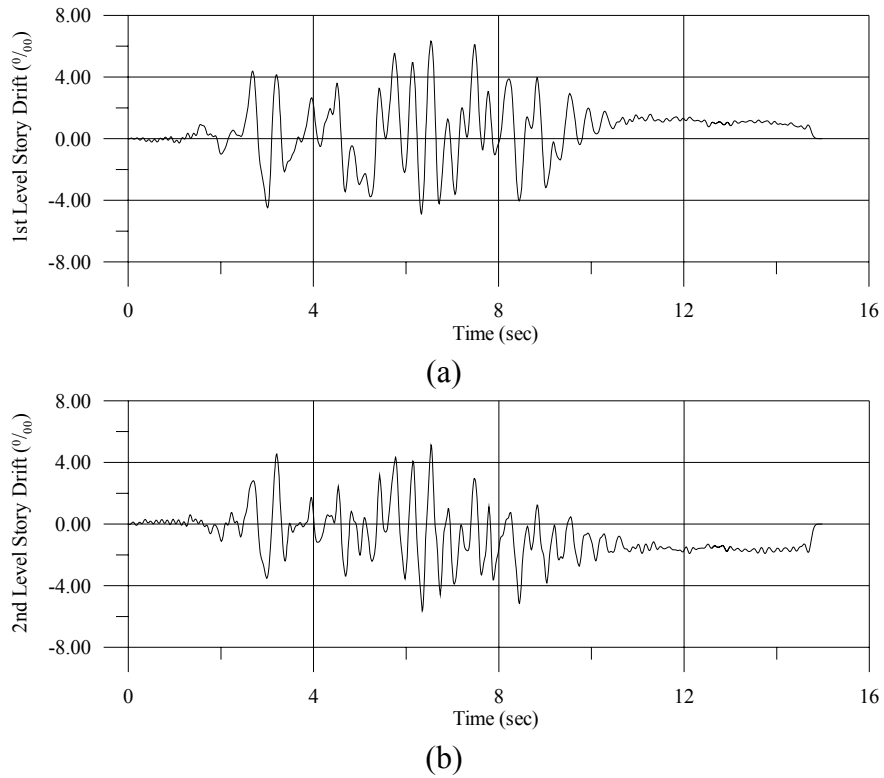

Figure 58. Specimen A3- Story drift time history Test 20: (a): 1<sup>st</sup> level, (b): 2<sup>nd</sup> Level.

Table 31. Specimen B1: Maximum Story drift of 1<sup>st</sup> and 2<sup>nd</sup> Level.

Test No	Min/Max	1 <sup>st</sup> Level Story drift (‰)	2 <sup>nd</sup> Level Story drift (‰)
4	Min	-1.52	-1.59
	Max	2.22	1.16
7	Min	-4.22	-5.38
	Max	3.98	3.78
8	Min	-4.65	-4.49
	Max	3.93	2.39
9	Min	-11.09	-9.75
	Max	7.39	5.49

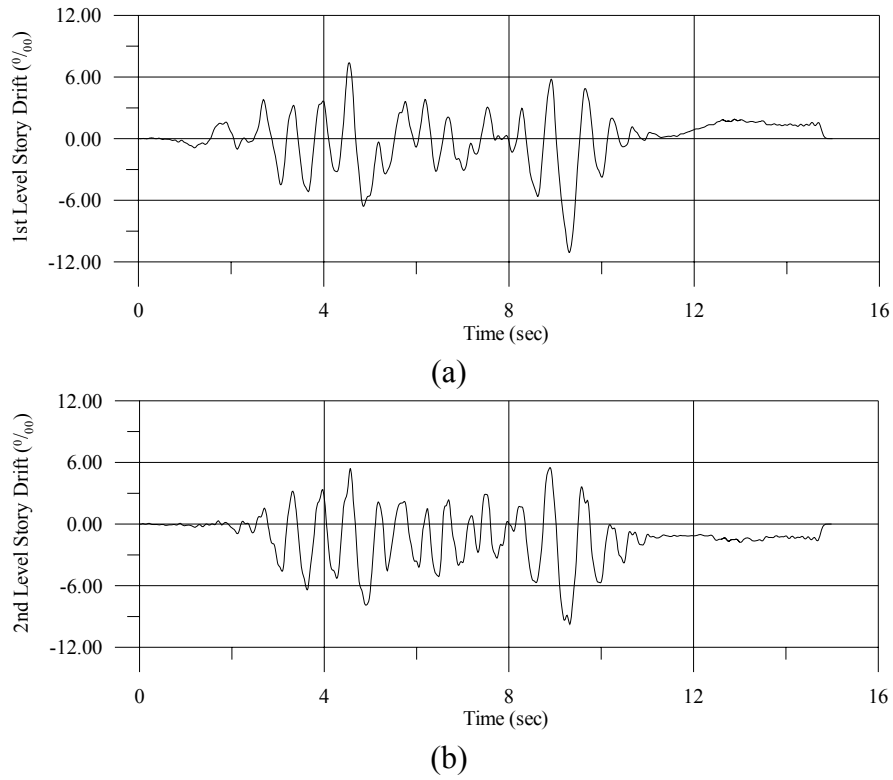

Figure 59. Specimen B1- Story drift time history Test 9: (a): 1<sup>st</sup> level, (b): 2<sup>nd</sup> Level.

Table 32. Specimen B2: Maximum Story drift of 1<sup>st</sup> and 2<sup>nd</sup> Level.

Test No	Min/Max	1 <sup>st</sup> Level Story drift (‰)	2 <sup>nd</sup> Level Story drift (‰)
4	Min	-1.32	-1.68
	Max	2.39	1.10
6	Min	-1.87	-1.15
	Max	2.69	0.72
7	Min	-2.72	-4.26
	Max	2.62	1.56

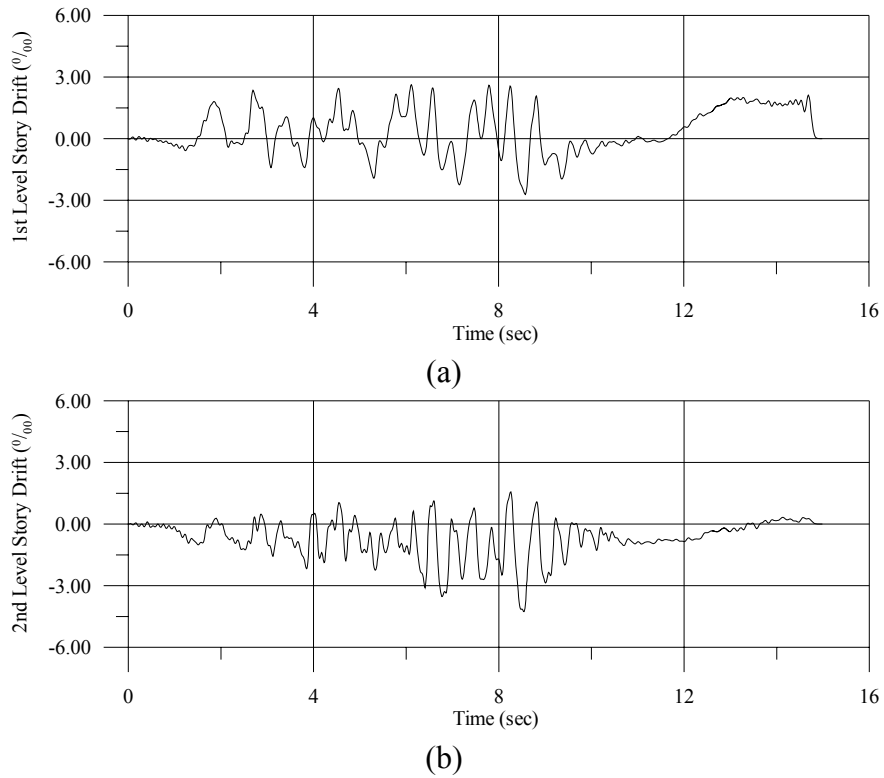

Figure 60. Specimen B2- Story drift time history Test 7: (a): 1<sup>st</sup> level, (b): 2<sup>nd</sup> Level.

Table 33. Specimen B2\*\*\*: Maximum Story drift of 1<sup>st</sup> Level.

Test No	Min/Max	1 <sup>st</sup> Level Story drift
		(‰)
4	Min	-5.91
	Max	5.75
9	Min	-20.09
	Max	16.97
10	Min	-18.06
	Max	20.12
11	Min	-33.41
	Max	25.74

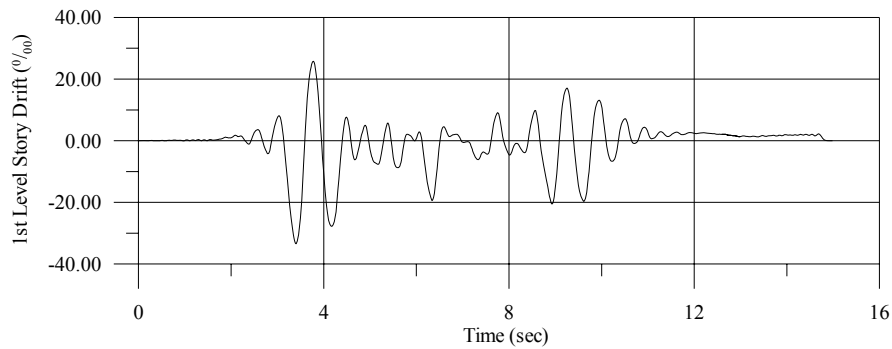
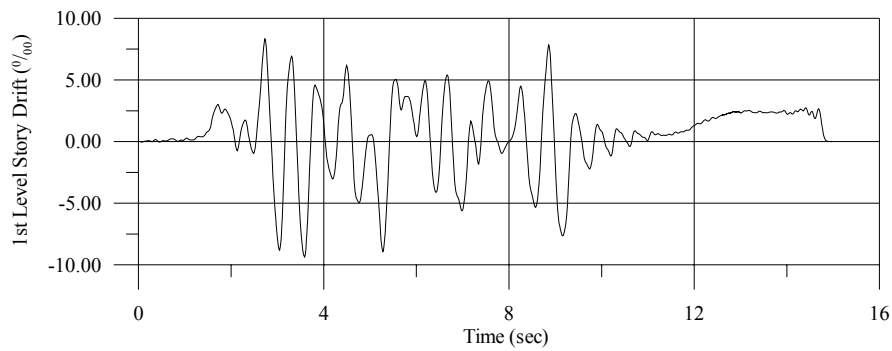

Figure 61. Specimen B2\*\*\*- Story drift time history Test 11: 1<sup>st</sup> Level.

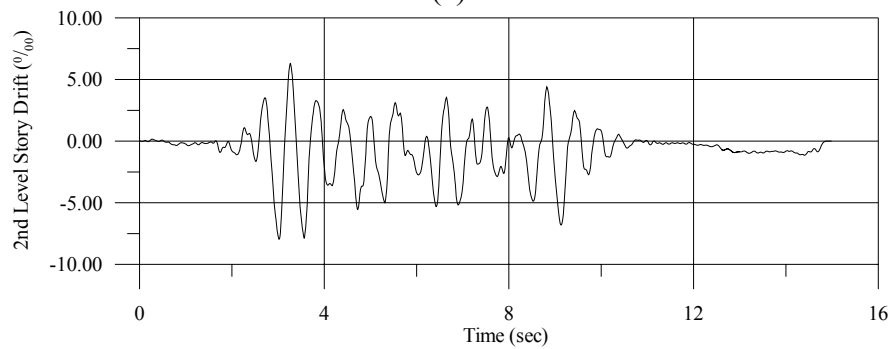

Table 34. Specimen B3: Maximum Story drift of 1<sup>st</sup> and 2<sup>nd</sup> Level.

Test No	Min/Max	1 <sup>st</sup> Level Story drift	2 <sup>nd</sup> Level Story drift
		(‰)	(‰)
4	Min	-0.85	-0.57
	Max	2.47	1.28
10	Min	-4.57	-5.73
	Max	5.48	4.45
11	Min	-5.72	-5.79
	Max	6.73	4.87
12	Min	-9.36	-7.96
	Max	8.32	6.29



(a)



(b)

Figure 62. Specimen B3- Story drift time history Test 12: (a): 1<sup>st</sup> level, (b): 2<sup>nd</sup> Level.

Table 35. Specimen B4: Maximum Story drift of 1<sup>st</sup> and 2<sup>nd</sup> Level.

Test No	Min/Max	1 <sup>st</sup> Level Story drift	2 <sup>nd</sup> Level Story drift
		(‰)	(‰)
4	Min	-0.27	-1.58
	Max	1.48	0.51
9	Min	-6.06	-5.75
	Max	3.89	2.06
10	Min	-7.11	-10.25
	Max	4.11	4.12

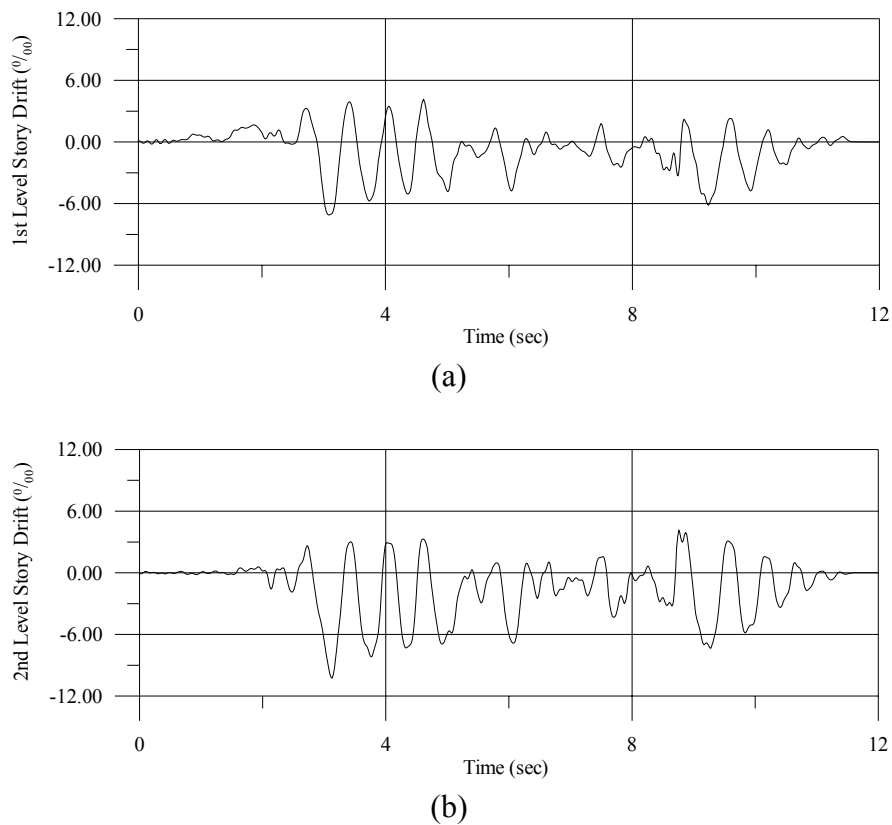

Figure 63. Specimen B4- Story drift time history Test 10: (a): 1<sup>st</sup> level, (b): 2<sup>nd</sup> Level.

### 6.6 Computation of ductility $\mu$ and behaviour factor $q$

When a member or a structure is analysed, concerning earthquake resistance, the main parameter to take into account is the ductility  $\mu$  which characterizes the ability of a structure or its components, or of the materials used to offer resistance in the inelastic response. This term can be calculated using the capacity curve of a structure or a member, or in the case of experimental research, the envelope of the hysteretic loops obtained from the experimental tests. Using the envelope of the hysteretic loops and making a bilinear idealization of the response, it is possible to calculate the ductility  $\mu$ . In EC 8, the bilinear curve should be based on the equal energy criteria which define that the amount of energy of the bilinear approximation should be equal to the energy dissipated in the real curve and the constant branch should be equal to the maximum force attained by the structure (Figure 64).

The ductility  $\mu$  is given as:

$$\mu = \frac{u^*}{u_e}$$

where  $u^*$  is the ultimate displacement attained by the structure and  $u_e$  is the yielding displacement (Figure 65). The ultimate displacement usually corresponds to the ultimate strength of the structure which is 80% of the maximum strength attained during the analysis. In this study, as the behaviour is characterised as brittle, the ultimate displacement is defined as the maximum displacement corresponding to the maximum capacity experienced during tests. In Figures 66 and 67, the envelop curve of hysteretic loops and the bilinear idealization of each specimen are presented. In Table 36, the ductility is given for each specimen.

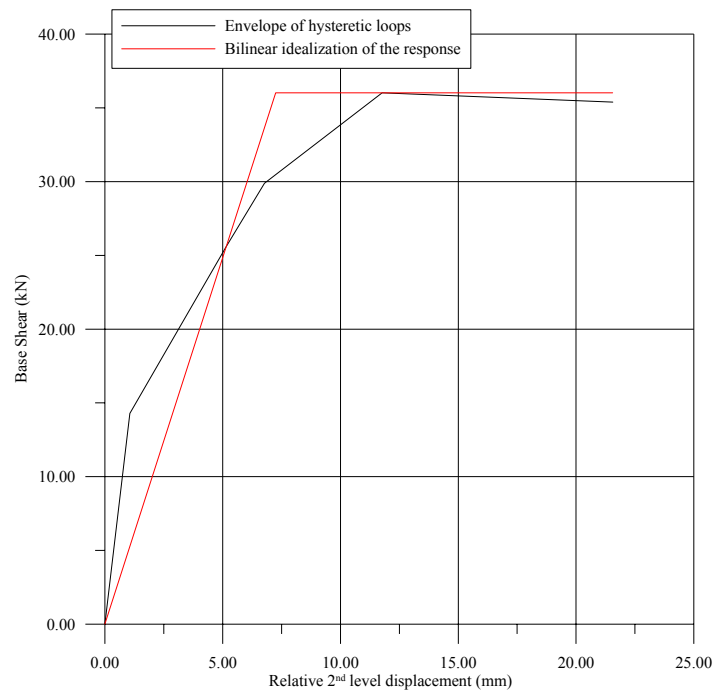

Figure 64. Envelope of hysteretic loops obtained from experimental data and bilinear idealization of the response which is based on equal energies criterion.

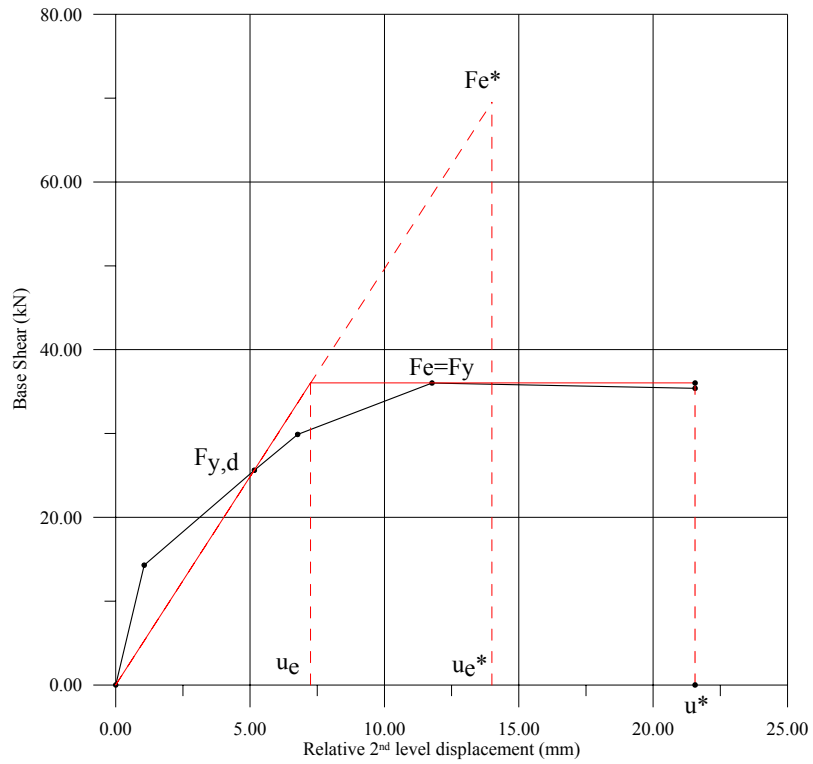

Figure 65. Definition of ductility  $\mu$ .

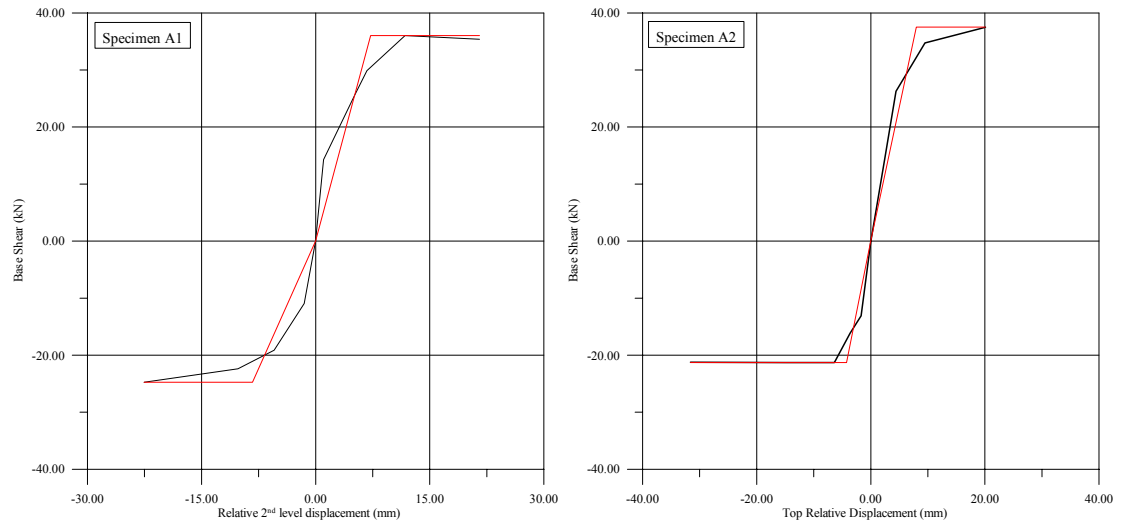

Figure 66. Envelope of hysteretic loops and bilinear idealization curve.

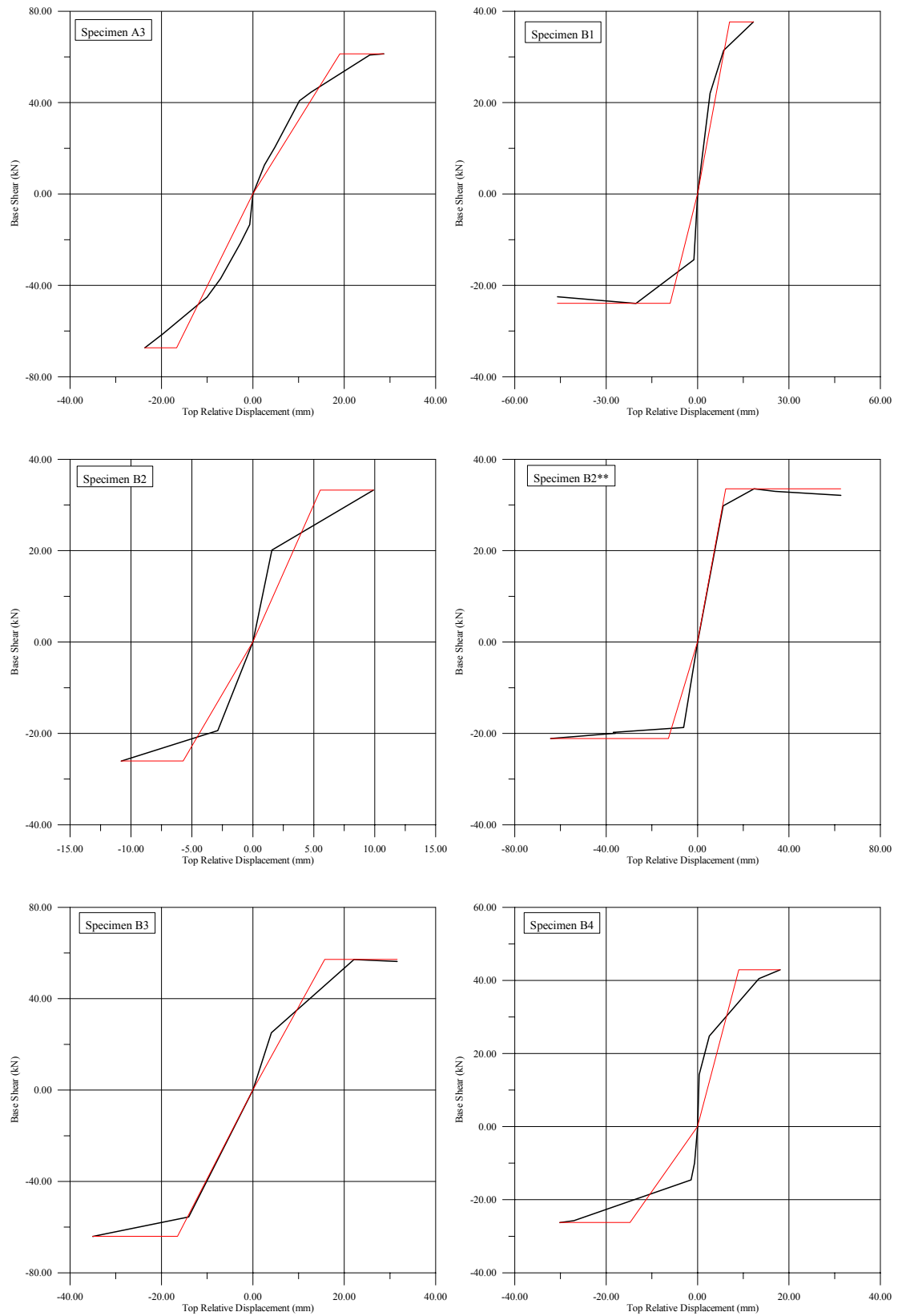

Figure 67. Envelope of hysteretic loops and bilinear idealization curve.

Table 36. Values of ductility  $\mu$  evaluated from experiments

Specimen	Positive direction			Negative direction		
	$u_e$ (mm)	$u^*$ (mm)	$\mu$	$u_e$ (mm)	$u^*$ (mm)	$\mu$
A1	7.25	21.56	2.97	8.28	22.54	2.73
A2	8.00	20.10	2.51	4.24	25.48	6.01
A3*	19.05	28.67	1.50	16.67	23.64	1.42
B1	10.53	18.34	1.74	8.93	45.97	4.84
B2	5.54	9.89	1.79	5.71	10.80	1.89
B3	15.76	31.58	2.00	16.47	35.02	2.13
B4	9.05	18.06	2.00	14.76	30.14	2.08

As specified in EC 8, the capacity of structural system to resist seismic actions in the nonlinear range generally permits the design for forces smaller than those corresponding to a linear elastic response. To avoid explicit inelastic structural analysis in design, the capacity of the structure to dissipate energy through mainly ductile behaviour of its elements and other mechanisms is taken into account by performing an elastic analysis based on a response spectrum reduced with respect to the elastic one by introducing the behaviour factor  $q$ . Depending on the masonry types of constructions, the range of values of the behaviour factor  $q$  according to EC 8 is as follows:

Unreinforced masonry: 1.50-2.50

Confined masonry: 2.00-3.00

Reinforced masonry: 2.50-3.00

The behaviour factor  $q$  is given as:

$$q = \frac{F_e^*}{F_{y,d}} = q_0 \cdot q_d$$

where  $F_e^*$  is the maximum force which corresponds to the ideal elastic system,  $F_{y,d}$  is

the design base shear,  $q_d = \frac{F_e^*}{F_y}$  and  $q_0 = \frac{F_y}{F_{y,d}}$  is the overstrength. In this research, the

design base shear assumes that equals with base shear corresponding to test with base acceleration 0.08g. For structures with  $T_{\text{structure}} \leq T_C$  the factor  $q_d$  is a function of ductility  $\mu$ . In Table 37, the factors  $q_d$ ,  $q_0$  and  $q$  are given for each specimen.

The formula  $q_d = \sqrt{2 \cdot \mu - 1}$  given in EC8 for structures with period less than  $T_C$  is found not to be valid in this experimental research.

Table 37. Values of factors  $q$ ,  $q_d$  and  $q_0$  evaluated from experiments.

Specimen	Specimen	$F_{y,d}$ (kN)	$F_e=F_y$ (kN)	$F_e^*$ (kN)	$q$	$q_{mean}$	$q_d$	$q_0$	$\mu$
Positive Direction	A1	25.62	36.02	64.05	2.50	2.50	1.78	1.41	2.97
	A2	26.28	37.51	64.91	2.47	2.47	1.73	1.43	2.51
	A3*	21.57	61.35	98.14	4.55	4.55	1.60	2.84	1.50
	B1	22.04	37.67	61.27	2.78	2.78	1.63	1.71	1.74
	B2	18.10	33.25	46.34	2.56	2.56	1.39	1.84	1.79
	B3	25.10	57.18	100.15	3.99	3.99	1.75	2.28	2.00
	B4	24.76	42.91	83.19	3.36	3.36	1.94	1.73	2.00
Negative Direction	A1	-19.15	-24.76	-47.88	2.50		1.93	1.29	2.73
	A2	-16.15	-21.29	-39.89	2.47		1.87	1.32	6.01
	A3*	-21.57	-67.32	-98.14	4.55		1.46	3.12	1.42
	B1	-14.40	-23.94	-40.03	2.78		1.67	1.66	4.84
	B2	-13.38	-26.05	-34.25	2.56		1.31	1.95	1.89
	B3	-21.06	-64.05	-84.03	3.99		1.31	3.04	2.13
	B4	-14.59	-26.25	-49.02	3.36		1.87	1.80	2.08

\*with additional mass

## 7 Conclusions

The experimental tests reported herein concern the seismic response of seven two storey, masonry buildings tested on the shaking table facility of the Laboratory for Earthquake Engineering at the National Technical University of Athens, Greece. Three types of units were examined: clay, calcium silicate and lightweight aggregate concrete units.

The main damages that were observed during tests are summarized as follows:

- Cracking and crushing of units, failure of perforations of clay units. Generally clay units suffered more damages than calcium silicate and lightweight concrete units. Stepped cracks through the joints at calcium silicate units.
- Stepped cracks through joints and units at clay and lightweight concrete units.
- Permanent out of plane displacement of transversal walls of both stories of T-shaped part of specimens for all types of units. Slabs were not tightly connected with the walls as they were prefabricated. Separation at the interface between transversal and horizontal wall of T-shaped part although steel connections were used. Permanent movement of reinforced concrete slabs, especially of 2<sup>nd</sup> Level.

That performance didn't appear for reinforced specimens. Specimens A3 and B3 with vertical confinement (reinforcement and concrete) were sustained severe earthquakes up to an input acceleration of 0.30g and 0.26g respectively. These specimens presented higher stiffness and strength than the unreinforced specimens.

- As one could be observed from base shear- top relative displacement diagrams, the response of all specimens is characterized as “brittle”.
- The ductility  $\mu$  calculated for unreinforced masonry is 2.50-2.97 for Calcium Silicate, 1.74-1.79 for Clay and 2.08 for Lightweight Aggregate Concrete. For reinforced masonry the ductility  $\mu$  is 1.50 for Calcium Silicate and 2.13 for Clay.
- The  $q$  factor calculated for unreinforced masonry is 2.47-2.50 for Calcium Silicate, 2.56-2.78 for Clay and 3.36 for Lightweight Aggregate Concrete. For reinforced masonry the  $q$  factor is 4.55 for Calcium Silicate and 4.00 for Clay.
- The  $q_d$  factor calculated for unreinforced masonry is 1.73-1.78 for Calcium Silicate, 1.40-1.63 for Clay and 1.87 for Lightweight Aggregate Concrete. For reinforced masonry the  $q_d$  factor is 1.60 for Calcium Silicate and 1.75 for Clay.
- The  $q_0$  factor calculated for unreinforced masonry is 1.41-1.43 for Calcium Silicate, 1.71-1.84 for Clay and 1.80 for Lightweight Aggregate Concrete. For reinforced masonry the  $q_0$  factor is 2.84 for Calcium Silicate and 3.04 for Clay.
- The formula  $q_d = \sqrt{2 \cdot \mu - 1}$  given in EC8 for structures with period less than  $T_C$  is found not to be valid in this experimental research. A new formula has to be established.

In Table 38, the absolute maximum base shear and the top relative displacement is given for all the specimens, while in Table 39 the absolute maximum calculated story drift is presented. In Table 40, the absolute maximum story drift for input acceleration 0.08 is given.



Table 38. Absolute maximum base shear and top relative displacement.

Specimen	Base Shear (kN)	2 <sup>nd</sup> Level relative Displacement (mm)
A1- optimised calcium silicate units	36.18	34.04
A2- optimised calcium silicate units with vertical perforation	37.51	34.53
A3*- calcium silicate optimised units with vertical perforation and vertical confinement	67.33	28.67
B1- clay optimised units	37.65	51.96
B2- two- stories structure with clay infill blocks	33.25	17.18
B2**- one- story structure with clay infill blocks	37.10	83.53
B3- clay infill blocks with vertical confinement	64.05	42.67
B4- Lightweight aggregate concrete units	42.91	43.25

\*with additional mass, \*\* one-story specimen

Table 39. Absolute maximum story drift for strong earthquake tests.

Specimen	Nominal Acceleration (g)	1 <sup>st</sup> Level story drift (‰)	2 <sup>nd</sup> Level story drift (‰)
A1- optimised calcium silicate units	0.16	4.99	10.72
A2- optimised calcium silicate units with vertical perforation	0.16	3.58	11.30
A3*- calcium silicate optimised units with vertical perforation and vertical confinement	0.30	6.33	5.13
B1- clay optimised units	0.18	11.09	9.75
B2- two- stories structure with clay infill blocks	0.14	2.72	4.26
B2**- one- story structure with clay infill blocks	0.34	33.41	-
B3- clay infill blocks with vertical confinement	0.24	9.36	7.96
B4- Lightweight aggregate concrete units	0.20	7.11	10.26

\*with additional mass, \*\* one-story specimen

Table 40. Absolute maximum story drift for input acceleration 0.08g

Specimen	1 <sup>st</sup> Level story drift (%)	2 <sup>nd</sup> Level story drift (%)
A1- optimised calcium silicate units	1.28	1.74
A2- optimised calcium silicate units with vertical perforation	2.85	0.62
A3*- calcium silicate optimised units with vertical perforation and vertical confinement	0.97	1.02
B1- clay optimised units	2.22	1.59
B2- two- stories structure with clay infill blocks	2.39	1.68
B2**- two- stories structure with clay infill blocks	5.91	-
B3- clay infill blocks with vertical confinement	2.47	1.28
B4- Lightweight aggregate concrete units	1.47	1.58

\*with additional mass, \*\* one-story specimen